

## N-Channel 40-V (D-S) MOSFET

PRODUCT SUMMARY				
V <sub>DS</sub> (V)	R <sub>DS(on)</sub> (Ω)	I <sub>D</sub> (A) <sup>a</sup>		Q <sub>g</sub> (Typ.)
		Silicon Limit	Package Limit	
40	0.0055 at V <sub>GS</sub> = 10 V	103	50	25 nC
	0.007 at V <sub>GS</sub> = 4.5 V	91	50	

Package Drawing  
[www.vishay.com/doc?73398](http://www.vishay.com/doc?73398)

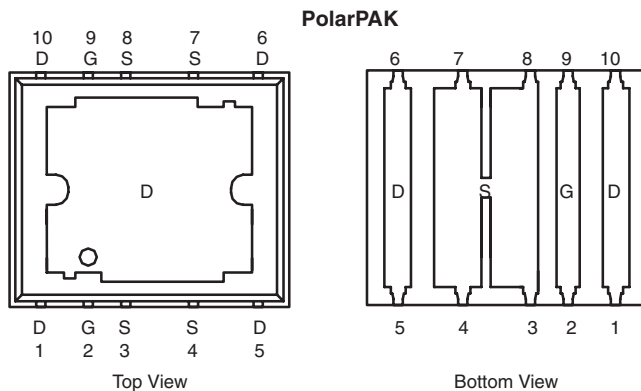

Top surface is connected to pins 1, 5, 6, and 10

**Ordering Information:** SiE832DF-T1-E3 (Lead (Pb)-free)  
SiE832DF-T1-GE3 (Lead (Pb)-free and Halogen-free)

### FEATURES

- Halogen-free According to IEC 61249-2-21 Definition
- TrenchFET<sup>®</sup> Power MOSFET
- Ultra Low Thermal Resistance Using Top-Exposed PolarPAK<sup>®</sup> Package for Double-Sided Cooling
- Leadframe-Based New Encapsulated Package
  - Die Not Exposed
  - Same Layout Regardless of Die Size
- Low Q<sub>gd</sub>/Q<sub>gs</sub> Ratio Helps Prevent Shoot-Through
- 100 % R<sub>g</sub> and UIS Tested
- Compliant to RoHS directive 2002/95/EC



### APPLICATIONS

- VRM
- Point-of-Load
- Synchronous Rectification

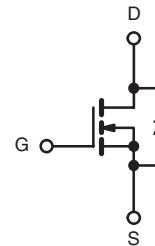

N-Channel MOSFET

For Related Documents  
[www.vishay.com/ppg?74414](http://www.vishay.com/ppg?74414)

ABSOLUTE MAXIMUM RATINGS T <sub>A</sub> = 25 °C, unless otherwise noted				
Parameter	Symbol	Limit	Unit	
Drain-Source Voltage	V <sub>DS</sub>	40		V
Gate-Source Voltage	V <sub>GS</sub>	± 20		
Continuous Drain Current (T <sub>J</sub> = 150 °C)	I <sub>D</sub>	T <sub>C</sub> = 25 °C	103 (Silicon Limit)	A
			50 <sup>a</sup> (Package Limit)	
		T <sub>C</sub> = 70 °C	50 <sup>a</sup>	
		T <sub>A</sub> = 25 °C	23.6 <sup>b, c</sup>	
	T <sub>A</sub> = 70 °C	18.9 <sup>b, c</sup>		
Pulsed Drain Current	I <sub>DM</sub>	80		
Continuous Source-Drain Diode Current	I <sub>S</sub>	T <sub>C</sub> = 25 °C	50 <sup>a</sup>	
		T <sub>A</sub> = 25 °C	4.3 <sup>b, c</sup>	
Single Pulse Avalanche Current	I <sub>AS</sub>	35		
Avalanche Energy	E <sub>AS</sub>	61		mJ
Maximum Power Dissipation	P <sub>D</sub>	T <sub>C</sub> = 25 °C	104	W
		T <sub>C</sub> = 70 °C	66	
		T <sub>A</sub> = 25 °C	5.2 <sup>b, c</sup>	
		T <sub>A</sub> = 70 °C	3.3 <sup>b, c</sup>	
Operating Junction and Storage Temperature Range	T <sub>J</sub> , T <sub>stg</sub>	- 55 to 150		°C
Soldering Recommendations (Peak Temperature) <sup>d, e</sup>		260		

Notes:

- Package limited is 50 A.
- Surface Mounted on 1" x 1" FR4 board.
- t = 10 s.
- See Solder Profile ([www.vishay.com/doc?73257](http://www.vishay.com/doc?73257)). The PolarPAK is a leadless package. The end of the lead terminal is exposed copper (not plated) as a result of the singulation process in manufacturing. A solder fillet at the exposed copper tip cannot be guaranteed and is not required to ensure adequate bottom side solder interconnection.
- Rework Conditions: manual soldering with a soldering iron is not recommended for leadless components.

**THERMAL RESISTANCE RATINGS**

Parameter		Symbol	Typical	Maximum	Unit
Maximum Junction-to-Ambient <sup>a, b</sup>	$t \leq 10$ s	$R_{thJA}$	20	24	°C/W
Maximum Junction-to-Case (Drain Top) <sup>a</sup>	Steady State	$R_{thJC}$ (Drain)	1	1.2	
Maximum Junction-to-Case (Source) <sup>a, c</sup>		$R_{thJC}$ (Source)	2.8	3.4	

Notes:

- a. Surface Mounted on 1" x 1" FR4 board.  
b. Maximum under Steady State conditions is 68 °C/W.  
c. Measured at source pin (on the side of the package).

**SPECIFICATIONS  $T_J = 25$  °C, unless otherwise noted**

Parameter	Symbol	Test Conditions	Min.	Typ.	Max.	Unit
<b>Static</b>						
Drain-Source Breakdown Voltage	$V_{DS}$	$V_{GS} = 0$ V, $I_D = 250$ $\mu$ A	40			V
$V_{DS}$ Temperature Coefficient	$\Delta V_{DS}/T_J$	$I_D = 250$ $\mu$ A		43.1		mV/°C
$V_{GS(th)}$ Temperature Coefficient	$\Delta V_{GS(th)}/T_J$		-6.9			
Gate-Source Threshold Voltage	$V_{GS(th)}$	$V_{DS} = V_{GS}$ , $I_D = 250$ $\mu$ A	1.5	2.2	3.0	V
Gate-Source Leakage	$I_{GSS}$	$V_{DS} = 0$ V, $V_{GS} = \pm 20$ V			$\pm 100$	nA
Zero Gate Voltage Drain Current	$I_{DSS}$	$V_{DS} = 40$ V, $V_{GS} = 0$ V			1	$\mu$ A
		$V_{DS} = 40$ V, $V_{GS} = 0$ V, $T_J = 55$ °C			10	
On-State Drain Current <sup>a</sup>	$I_{D(on)}$	$V_{DS} \geq 5$ V, $V_{GS} = 10$ V	25			A
Drain-Source On-State Resistance <sup>a</sup>	$R_{DS(on)}$	$V_{GS} = 10$ V, $I_D = 14$ A		0.0046	0.0055	$\Omega$
		$V_{GS} = 4.5$ V, $I_D = 12$ A		0.0058	0.007	
Forward Transconductance <sup>a</sup>	$g_{fs}$	$V_{DS} = 15$ V, $I_D = 13.6$ A		86		S
<b>Dynamic<sup>b</sup></b>						
Input Capacitance	$C_{iss}$	$V_{DS} = 20$ V, $V_{GS} = 0$ V, $f = 1$ MHz		3800		pF
Output Capacitance	$C_{oss}$		510			
Reverse Transfer Capacitance	$C_{rss}$		160			
Total Gate Charge	$Q_g$	$V_{DS} = 20$ V, $V_{GS} = 10$ V, $I_D = 20$ A		51	77	nC
		$V_{DS} = 20$ V, $V_{GS} = 4.5$ V, $I_D = 20$ A		25	38	
Gate-Source Charge	$Q_{gs}$		12			
Gate-Drain Charge	$Q_{gd}$		7			
Gate Resistance	$R_g$	$f = 1$ MHz		1.1	1.7	$\Omega$
Turn-On Delay Time	$t_{d(on)}$	$V_{DD} = 20$ V, $R_L = 2$ $\Omega$ $I_D \cong 10$ A, $V_{GEN} = 4.5$ V, $R_g = 1$ $\Omega$		45	70	ns
Rise Time	$t_r$		260	400		
Turn-Off Delay Time	$t_{d(off)}$		35	55		
Fall Time	$t_f$		55	85		
Turn-On Delay Time	$t_{d(on)}$	$V_{DD} = 20$ V, $R_L = 2$ $\Omega$ $I_D \cong 10$ A, $V_{GEN} = 10$ V, $R_g = 1$ $\Omega$		15	25	
Rise Time	$t_r$		30	45		
Turn-Off Delay Time	$t_{d(off)}$		35	55		
Fall Time	$t_f$		10	15		
<b>Drain-Source Body Diode Characteristics</b>						
Continuous Source-Drain Diode Current	$I_S$	$T_C = 25$ °C			50	A
Pulse Diode Forward Current <sup>a</sup>	$I_{SM}$				80	
Body Diode Voltage	$V_{SD}$	$I_S = 10$ A		0.8	1.2	V
Body Diode Reverse Recovery Time	$t_{rr}$	$I_F = 10$ A, $di/dt = 100$ A/ $\mu$ s, $T_J = 25$ °C		85	130	ns
Body Diode Reverse Recovery Charge	$Q_{rr}$		110	170	nC	
Reverse Recovery Fall Time	$t_a$		64		ns	
Reverse Recovery Rise Time	$t_b$		21			

Notes:

- a. Pulse test; pulse width  $\leq 300$   $\mu$ s, duty cycle  $\leq 2$  %  
b. Guaranteed by design, not subject to production testing.

Stresses beyond those listed under "Absolute Maximum Ratings" may cause permanent damage to the device. These are stress ratings only, and functional operation of the device at these or any other conditions beyond those indicated in the operational sections of the specifications is not implied. Exposure to absolute maximum rating conditions for extended periods may affect device reliability.

**TYPICAL CHARACTERISTICS** 25 °C, unless otherwise noted

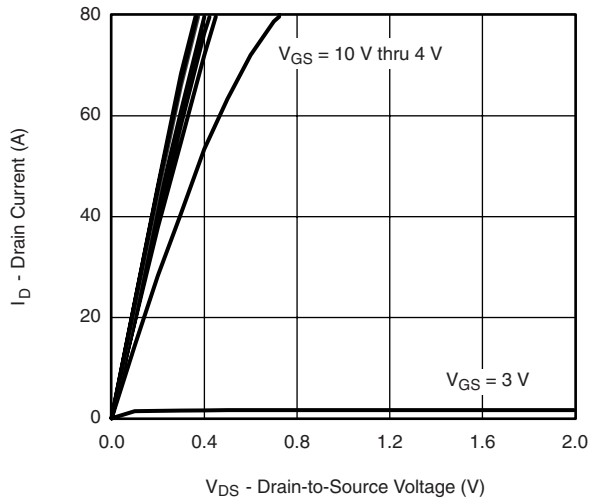

**Output Characteristics**

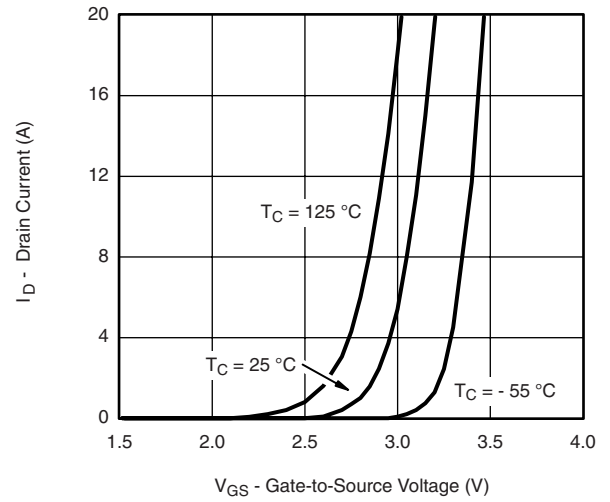

**Transfer Characteristics**

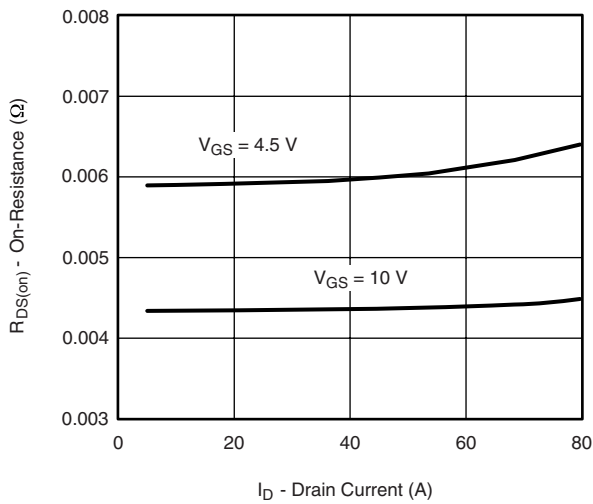

**On-Resistance vs. Drain Current**

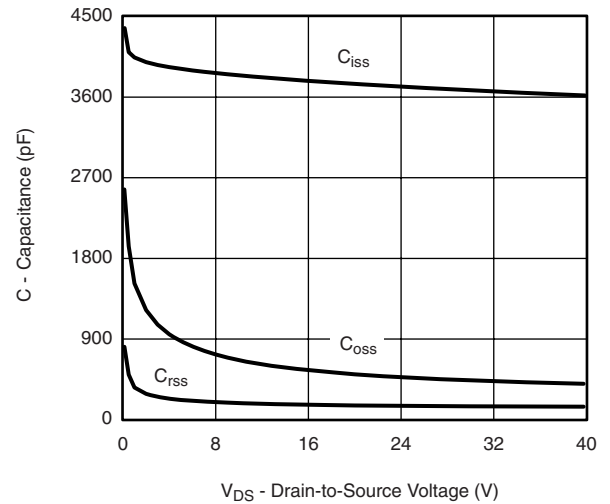

**Capacitance**

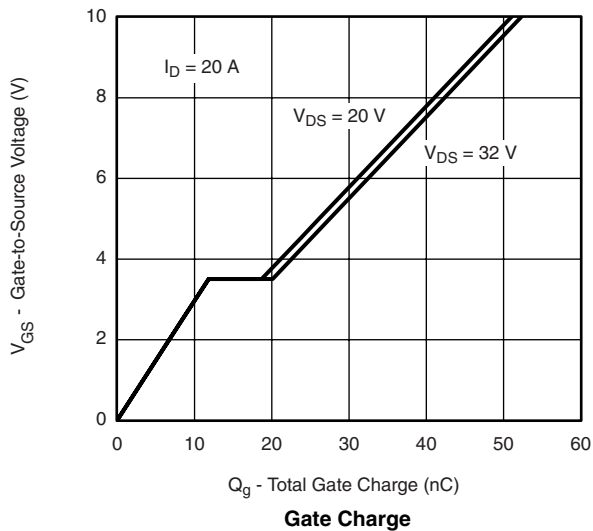

**Gate Charge**

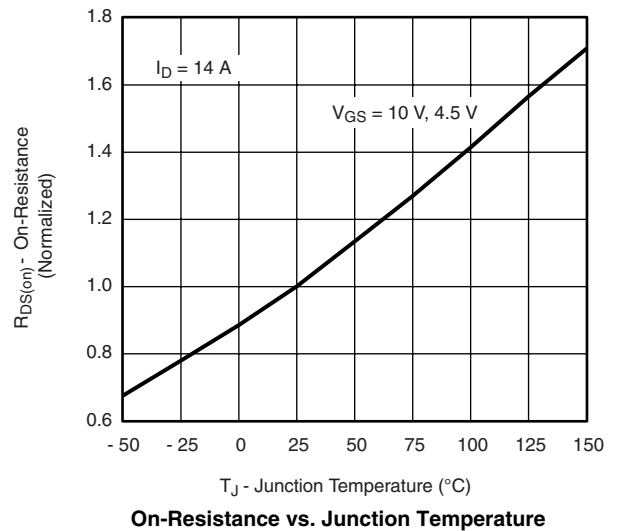

**On-Resistance vs. Junction Temperature**

**TYPICAL CHARACTERISTICS** 25 °C, unless otherwise noted

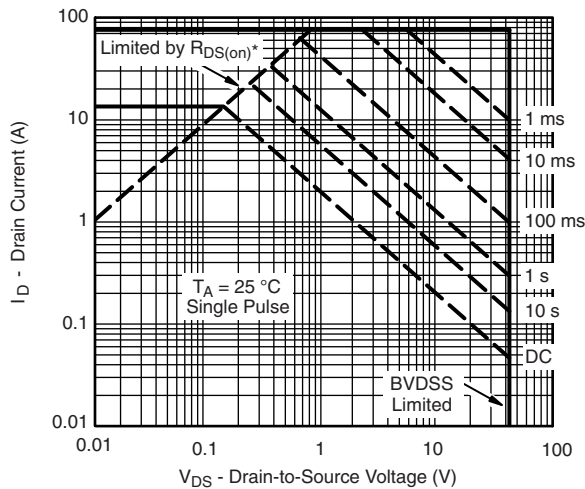
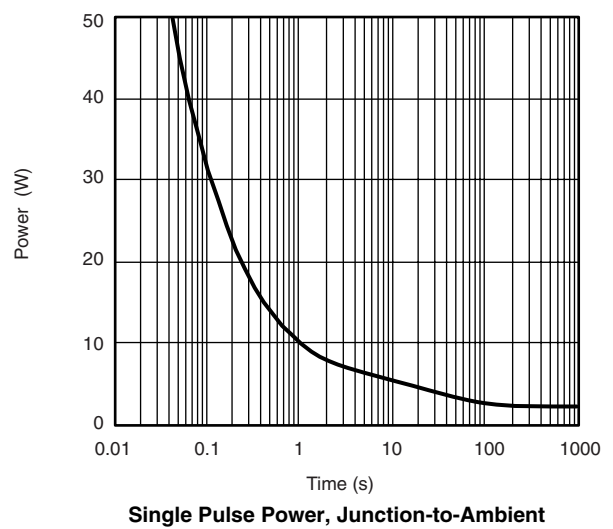
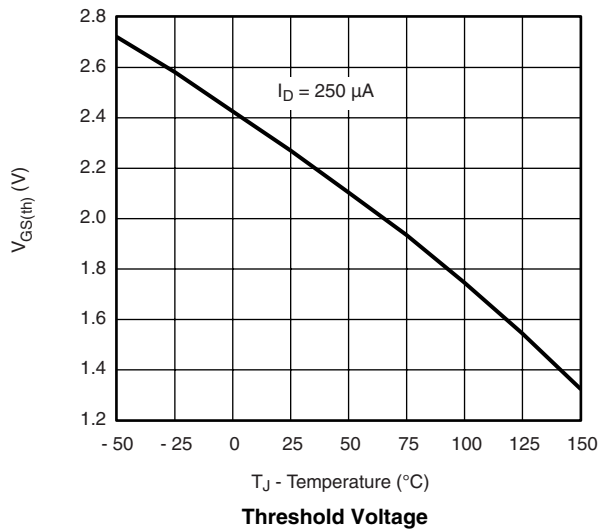
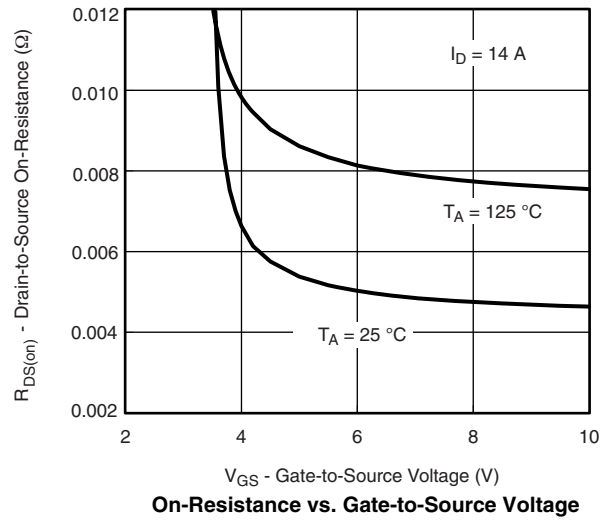
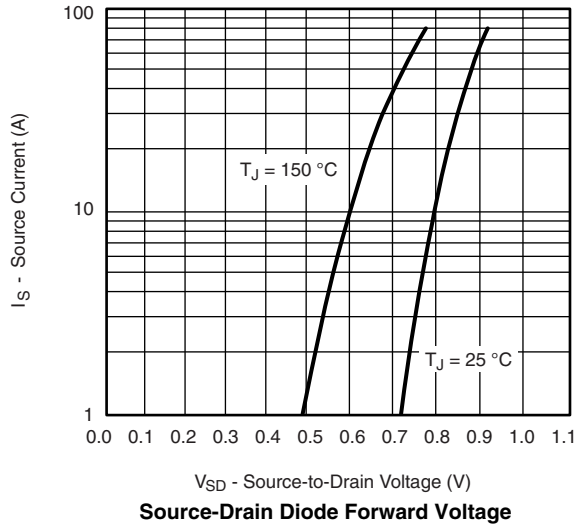

\*  $V_{GS} >$  minimum  $V_{GS}$  at which  $R_{DS(on)}$  is specified

**Safe Operating Area, Junction-to-Ambient**

**TYPICAL CHARACTERISTICS** 25 °C, unless otherwise noted

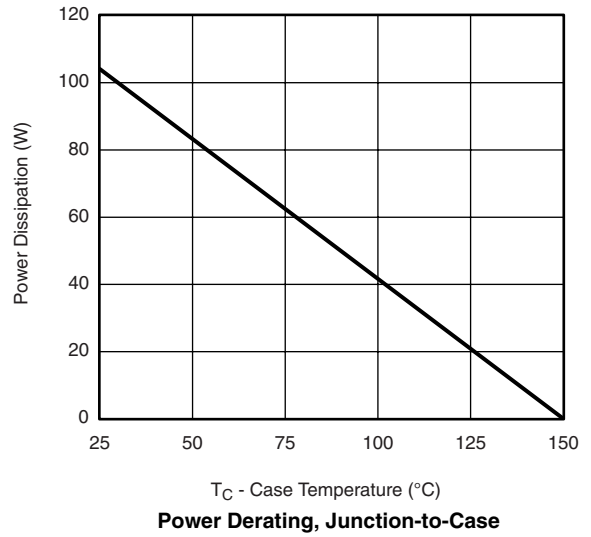
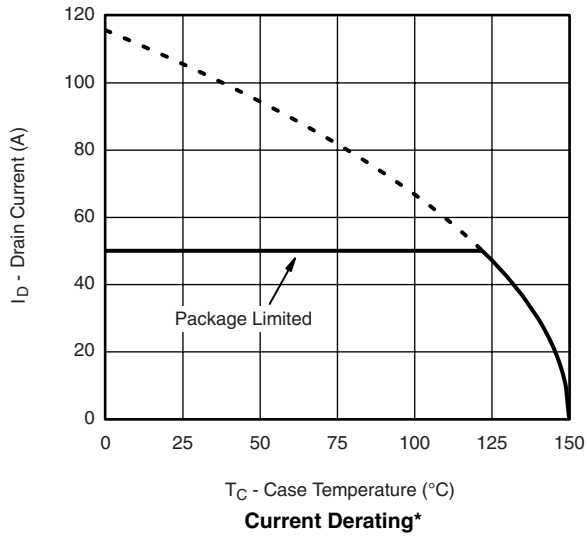

\* The power dissipation  $P_D$  is based on  $T_{J(max)} = 150$  °C, using junction-to-case thermal resistance, and is more useful in settling the upper dissipation limit for cases where additional heatsinking is used. It is used to determine the current rating, when this rating falls below the package limit.

**TYPICAL CHARACTERISTICS** 25 °C, unless otherwise noted

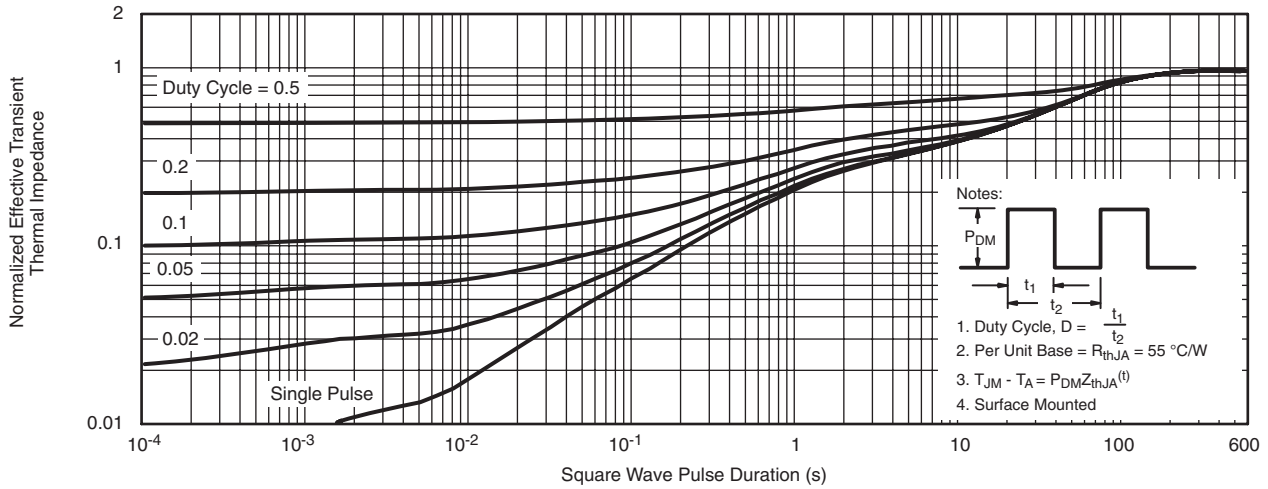

**Normalized Thermal Transient Impedance, Junction-to-Ambient**

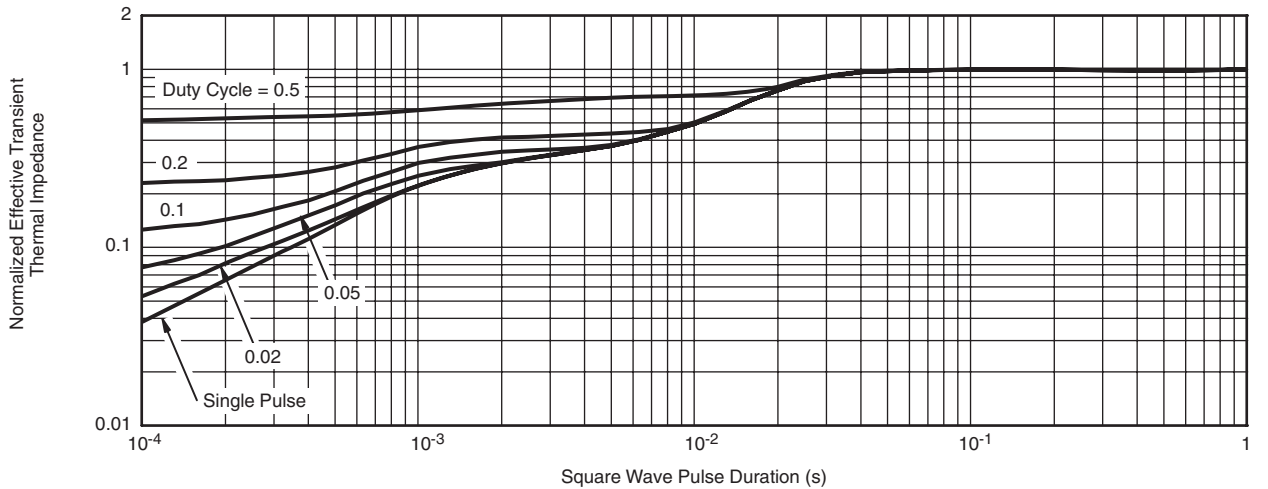

**Normalized Thermal Transient Impedance, Junction-to-Case (Drain Top)**

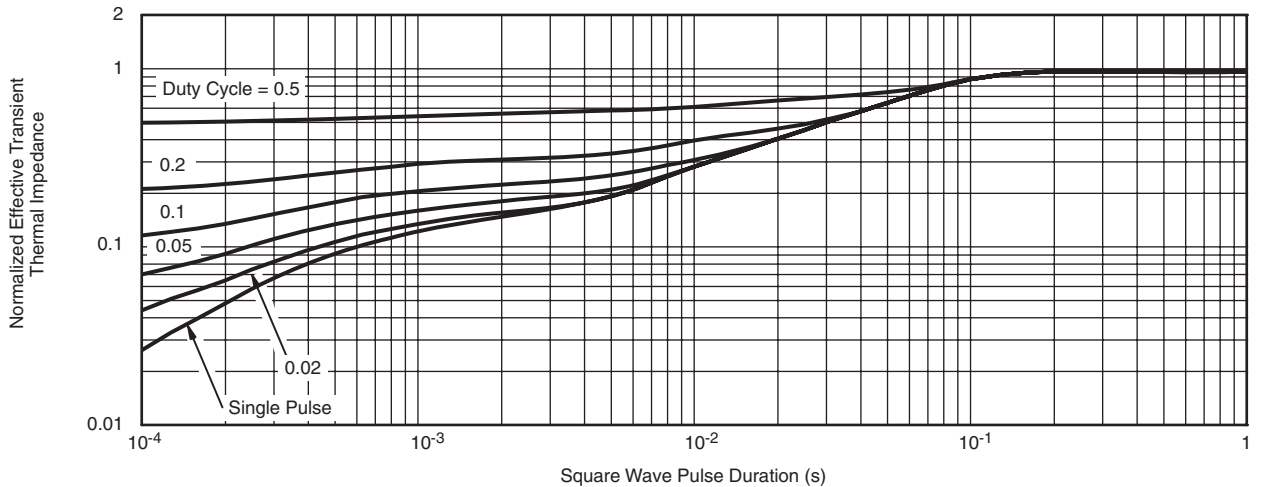

**Normalized Thermal Transient Impedance, Junction-to-Source**

Vishay Siliconix maintains worldwide manufacturing capability. Products may be manufactured at one of several qualified locations. Reliability data for Silicon Technology and Package Reliability represent a composite of all qualified locations. For related documents such as package/tape drawings, part marking, and reliability data, see [www.vishay.com/ppg?74414](http://www.vishay.com/ppg?74414).



**PolarPAK™ (Option S)**

Product datasheet/information page contain links to applicable package drawing.

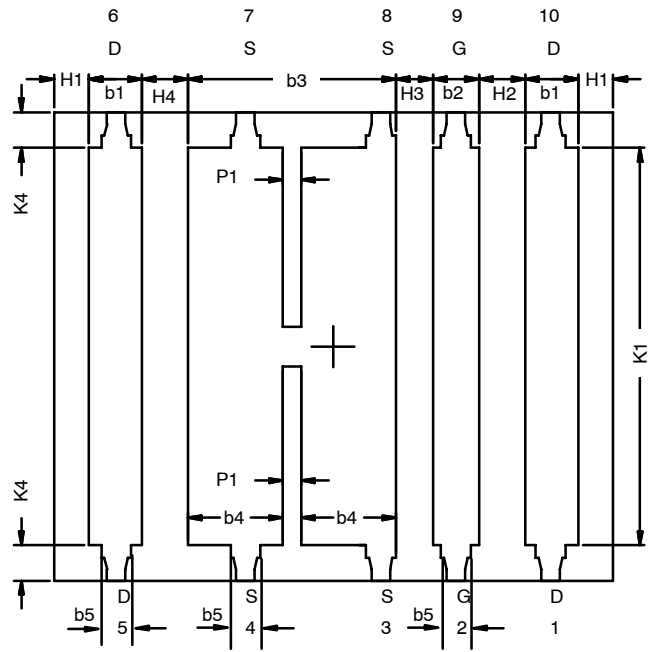
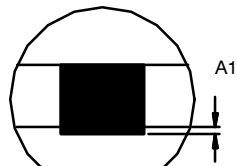
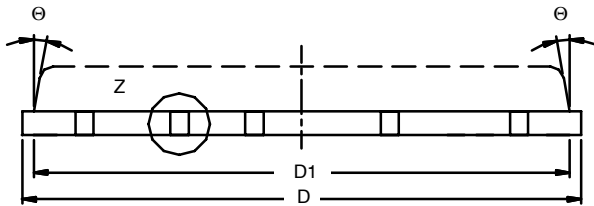
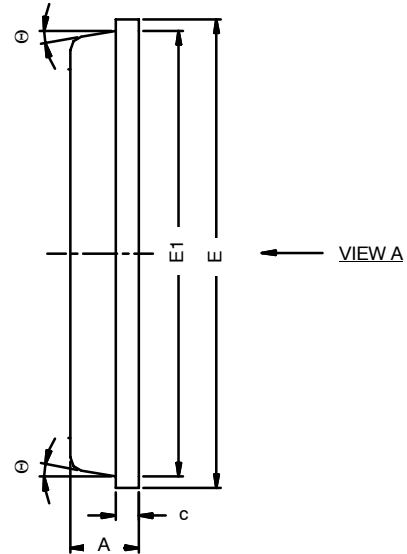
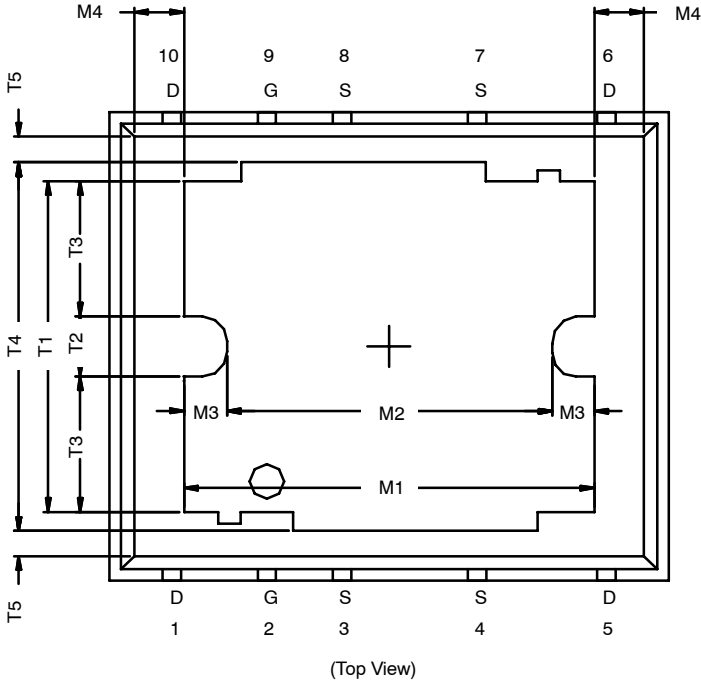



Dim	MILLIMETERS			INCHES		
	Min	Nom	Max	Min	Nom	Max
<b>A</b>	0.75	0.80	0.85	0.030	0.031	0.033
<b>A1</b>	0.00	-	0.05	0.000	-	0.002
<b>b1</b>	0.48	0.58	0.68	0.019	0.023	0.027
<b>b2</b>	0.41	0.51	0.61	0.016	0.020	0.024
<b>b3</b>	2.19	2.29	2.39	0.086	0.090	0.094
<b>b4</b>	0.89	1.04	1.19	0.035	0.041	0.047
<b>b5</b>	0.23	0.33	0.43	0.009	0.013	0.017
<b>c</b>	0.20	0.25	0.30	0.008	0.010	0.012
<b>D</b>	6.00	6.15	6.30	0.236	0.242	0.248
<b>D1</b>	5.74	5.89	6.04	0.226	0.232	0.238
<b>E</b>	5.01	5.16	5.31	0.197	0.203	0.209
<b>E1</b>	4.75	4.90	5.05	0.187	0.193	0.199
<b>H1</b>	0.23	-	-	0.009	-	-
<b>H2</b>	0.45	-	0.56	0.020	-	0.022
<b>H3</b>	0.31	0.41	0.51	0.012	0.016	0.020
<b>H4</b>	0.45	-	0.56	0.020	-	0.022
<b>K1</b>	4.22	4.37	4.52	0.166	0.172	0.178
<b>K4</b>	0.24	-	-	0.009	-	-
<b>M1</b>	4.30	4.50	4.70	0.169	0.177	0.185
<b>M2</b>	3.43	3.58	3.73	0.135	0.141	0.147
<b>M3</b>	0.22	-	-	0.009	-	-
<b>M4</b>	0.05	-	-	0.002	-	-
<b>P1</b>	0.15	0.20	0.25	0.006	0.008	0.010
<b>T1</b>	3.48	3.64	4.10	0.137	0.143	0.150
<b>T2</b>	0.56	0.76	0.95	0.22	0.030	0.037
<b>T3</b>	1.20	-	-	0.051	-	-
<b>T4</b>	3.90	-	-	0.154	-	-
<b>T5</b>	0	0.18	0.36	0.000	0.007	0.014
<b>Θ</b>	0°	10°	12°	0°	10°	12°
ECN: S-51049—Rev. B, 13-Jun-05 DWG: 5947						

Note: Millimeters govern over inches



## RECOMMENDED MINIMUM PADS FOR PolarPAK® Option L and S



Recommended Minimum for PolarPAK Option L and S  
 Dimensions in mm/(Inches)  
 No External Traces within Broken Lines  
 Dot indicates Gate Pin (Part Marking)



## Disclaimer

ALL PRODUCT, PRODUCT SPECIFICATIONS AND DATA ARE SUBJECT TO CHANGE WITHOUT NOTICE TO IMPROVE RELIABILITY, FUNCTION OR DESIGN OR OTHERWISE.

Vishay Intertechnology, Inc., its affiliates, agents, and employees, and all persons acting on its or their behalf (collectively, "Vishay"), disclaim any and all liability for any errors, inaccuracies or incompleteness contained in any datasheet or in any other disclosure relating to any product.

Vishay makes no warranty, representation or guarantee regarding the suitability of the products for any particular purpose or the continuing production of any product. To the maximum extent permitted by applicable law, Vishay disclaims (i) any and all liability arising out of the application or use of any product, (ii) any and all liability, including without limitation special, consequential or incidental damages, and (iii) any and all implied warranties, including warranties of fitness for particular purpose, non-infringement and merchantability.

Statements regarding the suitability of products for certain types of applications are based on Vishay's knowledge of typical requirements that are often placed on Vishay products in generic applications. Such statements are not binding statements about the suitability of products for a particular application. It is the customer's responsibility to validate that a particular product with the properties described in the product specification is suitable for use in a particular application. Parameters provided in datasheets and / or specifications may vary in different applications and performance may vary over time. All operating parameters, including typical parameters, must be validated for each customer application by the customer's technical experts. Product specifications do not expand or otherwise modify Vishay's terms and conditions of purchase, including but not limited to the warranty expressed therein.

Except as expressly indicated in writing, Vishay products are not designed for use in medical, life-saving, or life-sustaining applications or for any other application in which the failure of the Vishay product could result in personal injury or death. Customers using or selling Vishay products not expressly indicated for use in such applications do so at their own risk. Please contact authorized Vishay personnel to obtain written terms and conditions regarding products designed for such applications.

No license, express or implied, by estoppel or otherwise, to any intellectual property rights is granted by this document or by any conduct of Vishay. Product names and markings noted herein may be trademarks of their respective owners.