

## ※ Package Outline

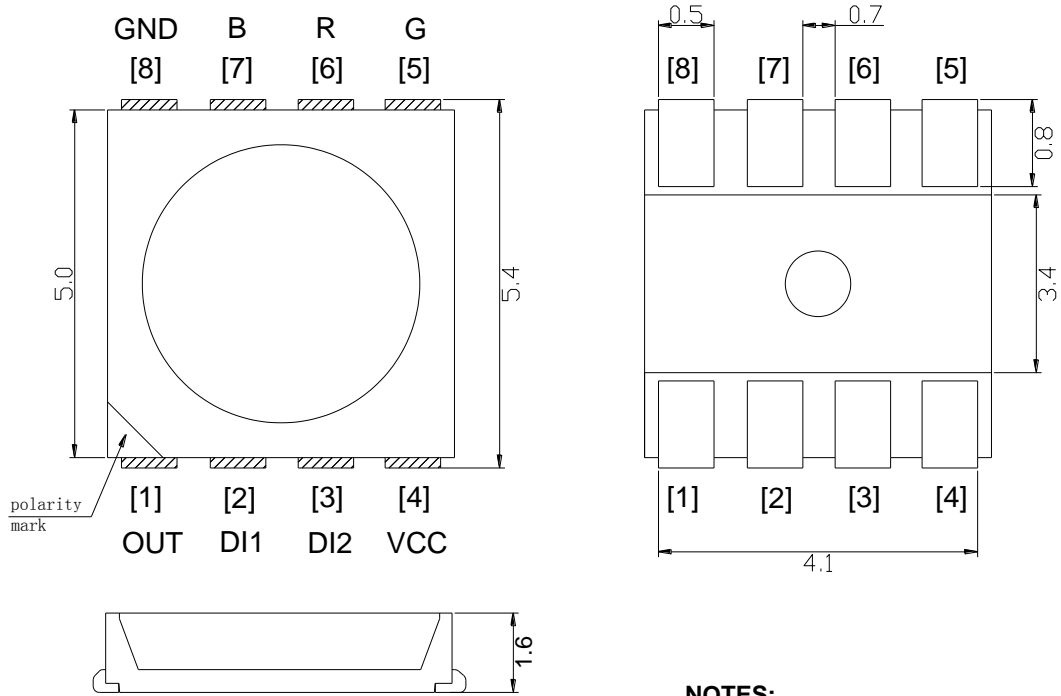

### NOTES:

1. All dimensions are in millimeters (inches);
2. Tolerances are  $\pm 0.2\text{mm}$  (0.008inch) unless otherwise noted.

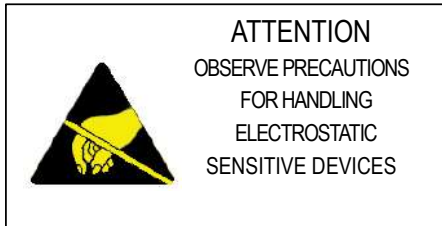

## Pin function

PIN	symbol	role	function
1	OUT	Data out	Control Data out
2	DI1	1st data in	Control Data in
3	DI2	2nd data in	Control Data in
4	VCC	Power	Power IC
5、6、7	R、G、B	RGB driving	RGB 3-lane data feedback
8	GND	Ground	Ground

※ Absolute maximum ratings at Ta=25°C

Parameter	Symbol	Value	Unit
Power Supply Voltage	VDD	4.5-7.5	V
LED voltage	VLED	5	V
PWM frequency	PWM	1.6	KHZ
Max output current	Iomax	18	mA
Via current misfit	DIO	In the chip<3%, Between the chips <5%	
Power dissipation	Pd	<350	mW
Forward current	If	20	mA
Reverse voltage	Vr	5	V
Operating temperature range	Top	-25~+80	°C
Storage temperature range	Tstg	-40~+100	°C

NOTE: IFP Conditions: Pulse Width  $\leq$  10msec. and Duty cycle  $\leq$  1/10.

※ Electrical-optical characteristics at Ta=25°C

Parameter	Test Condition	Symbol	Value			Unit	
			Min.	Typ.	Max.		
Forward voltage	If=20mA	VF	R	2.0	--	2.4	V
			G	3.0	--	3.4	
			B	3.0	--	3.4	
Luminous intensity	If=20mA	IV	R	800	--	900	mcd
			G	1400	--	1600	
			B	300	--	450	

WLD	If=20mA	WD	R	620	--	630	nm
			G	520	--	530	
			B	465	--	475	
Viewing angle at 50% Iv	If=20mA	2 θ 1/2	--	120	--		Deg
Reverse current	Vr=5V	Ir	--	--	10		μA

NOTE: 1. Tolerance of luminous intensity is  $\pm 5\%$

2. Tolerance of forward voltage is  $\pm 0.05V$

### ※Communication protocol& sequential

1. Input code

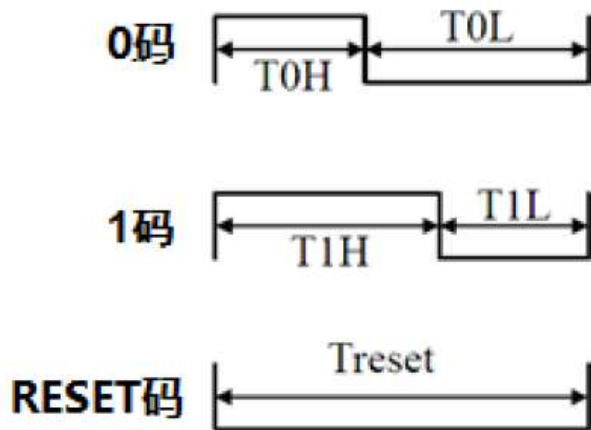

2. High speed mode

	Description	Typ.	Error allowed
TOH	0 code, High speed	0.35us	$\pm 150ns$
T1H	1 code, High speed	1.36us	$\pm 150ns$
TOL	0 code, Low speed	1.36us	$\pm 150ns$
T1L	1 code, Low speed	0.35us	$\pm 150ns$
WT	Waiting time	12us	$\pm 150ns$
RES	Reset code	50us	

### 3.Data transfer

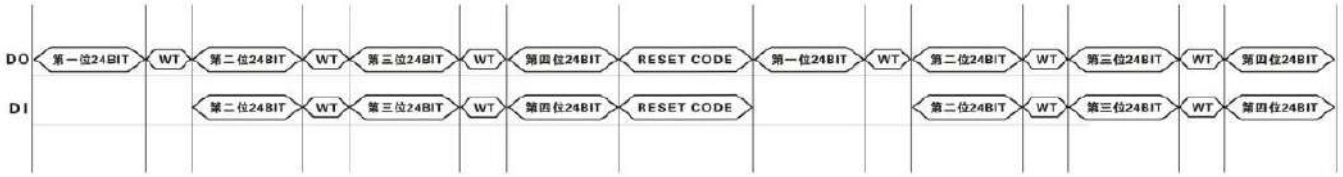

Note: D0 and D1 are the data sent by the MCU. The customer can only send the D0 signal, and the D1 chip will think that the signal is abnormal. This does not cause the signal to be delay transmitted.

### 4.24bit statistic structure

R7	R6	R5	R4	R3	R2	R1	R0	G7	G6	G5	G4	G3	G2	G1	G0	B7	B6	B5	B4	B3	B2	B1	B0
----	----	----	----	----	----	----	----	----	----	----	----	----	----	----	----	----	----	----	----	----	----	----	----

Note: Follow the order of RGB and the high bit sent first

### ※ Typical optical characteristics curves

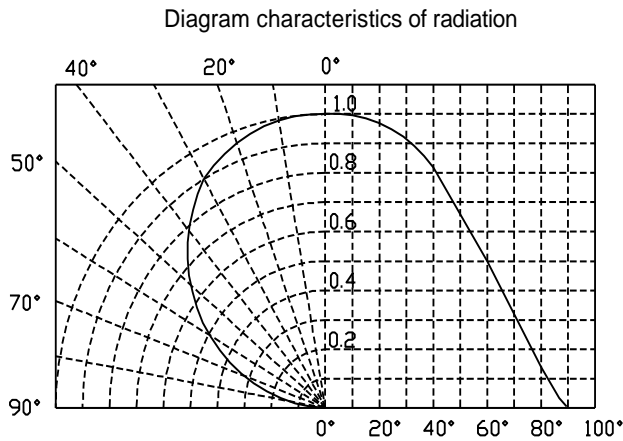
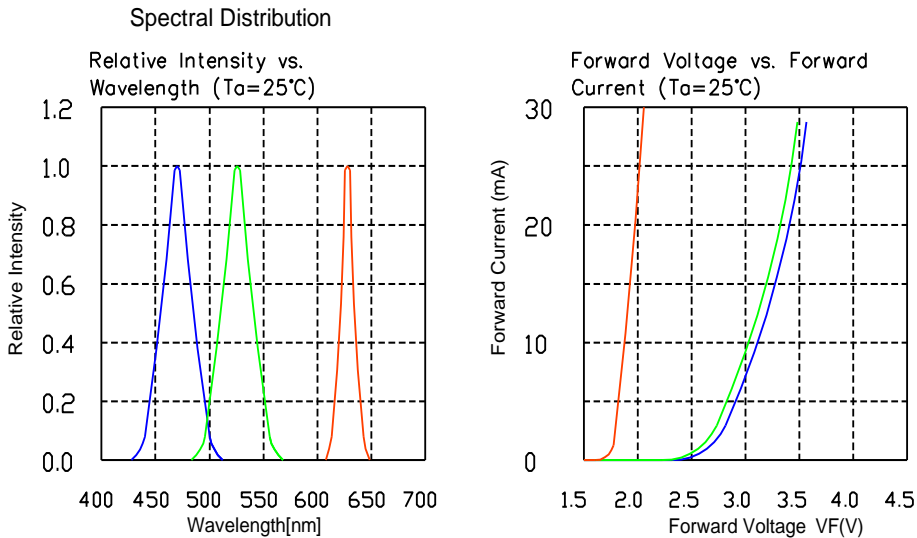

## ※Application specification

### 1.12VDC application note:

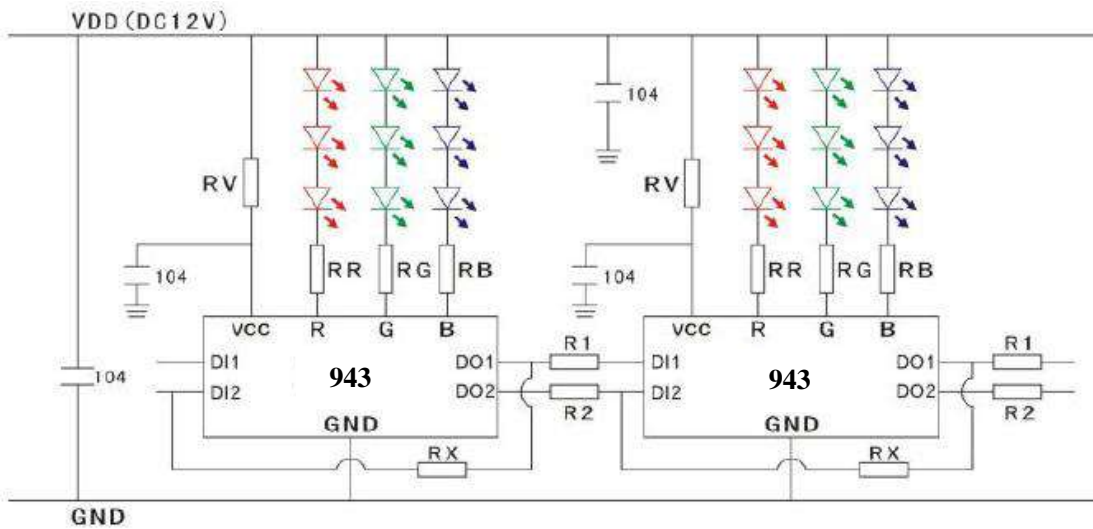

Remark: 12V RV takes 2.7K resistor; 24V RV takes 6.8K resistor, RX resistor takes 39ohm. The signal resistor should be a 70-100 ohm resistor to prevent the signal from being connected. The current-limiting resistor is calculated as:  $R = (VDD - VLED - VDS) / 18mA$ , (VDD is supplied to the LED voltage; VLED is the voltage of the LED, for example, three red The lamp voltage is  $2 \times 3 = 6$ , then the VLED is 6V; the VDS is generally 1V.)

### 2. Cascaded signal driving capability and connection method:

Due to the design of the signal regeneration circuit inside the chip, the cascading signal driving capability is greatly enhanced. It is recommended to use twisted pair to increase the transmission distance. To enhance the anti-jamming capability, add two 20P decoupling capacitors close to the IC input. Recommended for short-distance transmission, after the series resistors of DO1 and DO2 are connected to the lower stage to prevent signal reflection; the working voltage is 4.5V-12V, the resistance is 39 ohm, and the resistor should be installed close to the output of the IC. . It is recommended to connect the ESD protection tube to the DI1 and DI2 ports at the working voltage of 24V to protect the input port from high voltage damage.