

2019

RF Product Catalog

Peregrine RF Solutions using UltraCMOS® Technology

Peregrine Semiconductor RF products are produced by pSemi Corporation, a Murata company focused on semiconductor integration. For more than three decades, the Peregrine name has been synonymous with semiconductor innovation. In 1988, Peregrine’s founders laid the foundation for our UltraCMOS® technology platform—a patented, advanced form of silicon on insulator (SOI) delivering the performance edge our customers have come to expect from products produced by pSemi.

Peregrine and pSemi RF products are trusted by over 4000 customers in markets ranging from automotive, broadband, industrial, and the Internet of Things (IoT) to mobile devices, test and measurement equipment, and wireless infrastructure. Our proven technology and processes have pushed the limits of integration

and linearity—making us uniquely ready to deliver on the stringent needs of 5G. More than 650 issued and pending patents protect our products, and our team has shipped more than 5 billion UltraCMOS units.



In January 2018, Peregrine Semiconductor changed its corporate name to pSemi Corporation. The products in this catalog include the original products, still branded Peregrine Semiconductor, and new products that are branded under the pSemi brand name.

Table of Contents

Peregrine RF Solutions 2

High-performance RF Products 3

General-purpose RF Switches	4, 5
Test and Measurement Switches	6
Extended Temperature Switches	6
True DC RF Switch	7
High-power RF Switches	7
Automotive AEC-Q100 Certified Switches	8
Wired Broadband 75Ω Switches	8
Glitch-less Digital Step Attenuators (DSA).	9
50Ω Digital Step Attenuators	9
75Ω Digital Step Attenuators	9
Monolithic Phase and Amplitude Controller (MPAC) Devices	10
Switch + LNAs	11
Power Limiting Devices	11

Mixers	12
Digital Phase Shifter	12
Prescaler	12
Wi-Fi Front End Modules	12
Digital Tuning Solutions	13

Quality and Reliability 14

Technology Advantages	14
Going Green Starts on the Inside	15
RoHS-compliant Commercial Packaging	15

Design and Application Support 16

Sales Offices	16
-------------------------	----

High-performance RF Products

RF complexity is growing exponentially as more wireless devices compete for signals throughout more frequency bands, and our products continue to achieve several SOI industry firsts that offer RF engineers the widest range of high-performance

RF choices. UltraCMOS products allow engineers the flexibility to prioritize attributes—like small form factor, low power consumption, high reliability, radiation tolerance, high ESD ratings, programmability, affordability, reduced board area—based on use case.

Linearity Figure of Merit: PO.1dB

An UltraCMOS switch exhibits close to ideal linearity behavior up to the input 0.1dB compression point (PO.1dB), which remains invariant over power supply voltages.

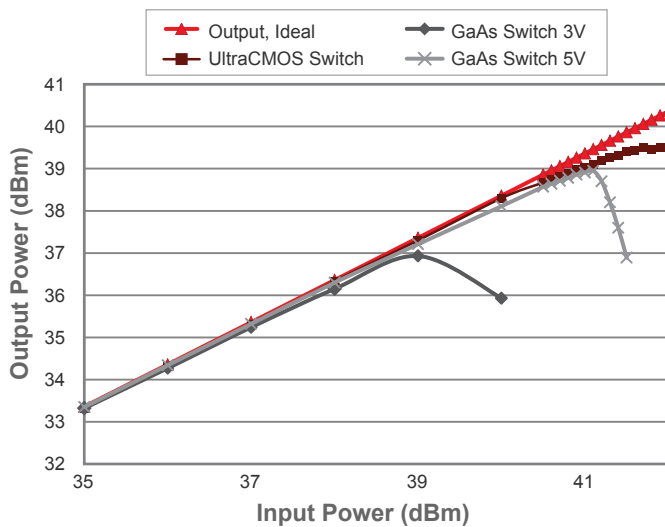

UltraCMOS switches do not compress in the same manner as switches on other technology processes, and a traditional P1dB measurement cannot be performed. Because UltraCMOS switch linearity is defined by the power handling capabilities of each switch, the PO.1dB compression point (derived from P_{MAX}) is used as the figure of merit to reflect each switch's true linearity performance.

Industry-leading Linearity Performance

PE42723 second and third harmonics ($P_{IN} = 65 \text{ dBmV}$)

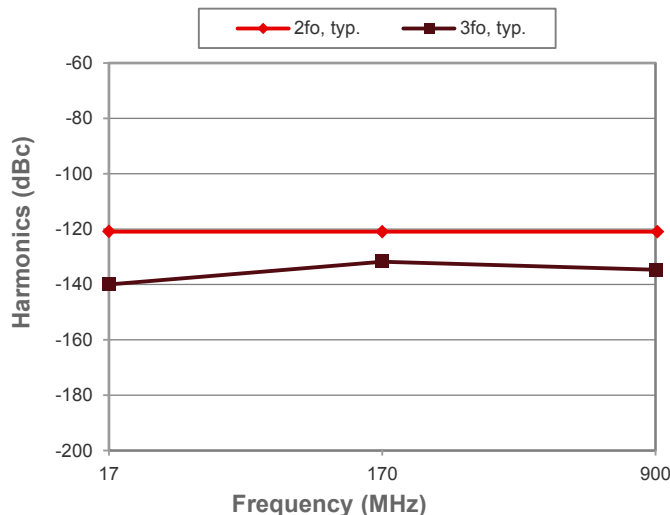

The PE42723 SPDT RF switch for DOCSIS 3.1/3.0 features unmatched linearity performance enabled by UltraCMOS technology, the only technology capable of addressing the linearity challenges of the future.

Core Technology Benefits

UltraCMOS solutions provide high-performance RF, mixed-signal, passive elements and digital functions on a single device.

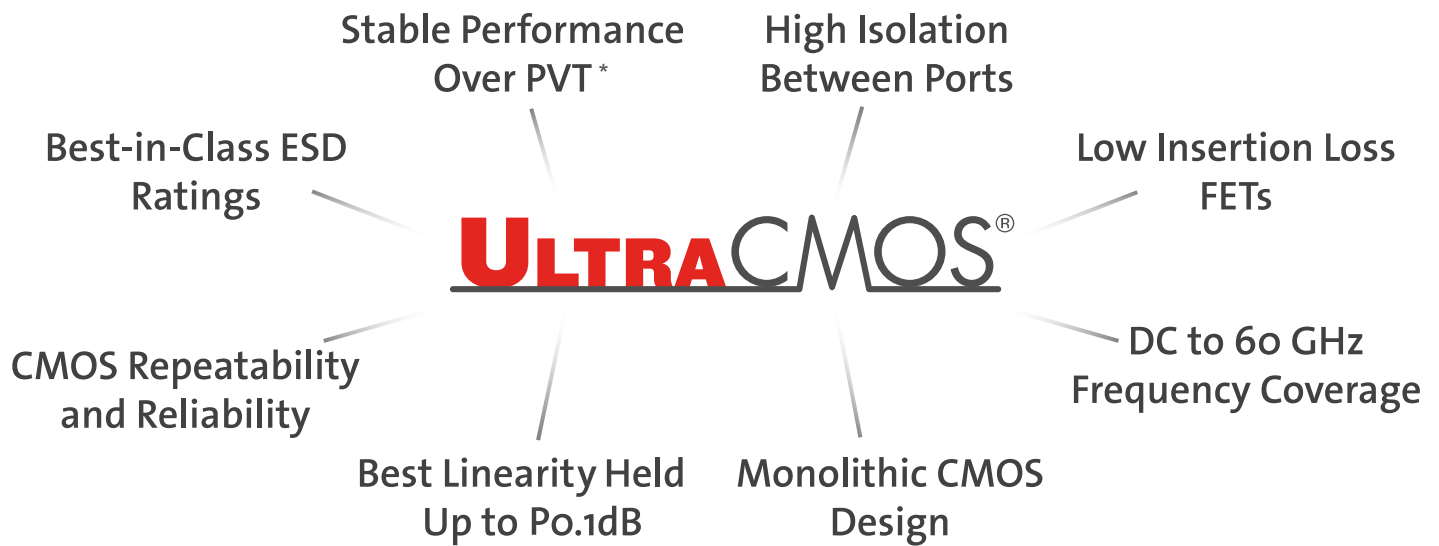

* PVT = Process, Voltage & Temperature

General-purpose RF Switches

Our broadband and general-purpose RF switches deliver an industry-leading combination of insertion loss, isolation, linearity and settling time, while routing RF signals to their respective transmit or receive paths.

General-purpose RF Switches — 50Ω															
Product Description ¹	Part Number	Product Highlight	Operating Frequency (MHz)		IIP3 (dBm)	Pmax CW (dBm)	P0.1dB (dBm)	Insertion Loss (dB)		Isolation (dB)		V _{DD} Range (V)	Switching Time (μs) ²	ESD HBM (V)	Package
			Min	Max				Min	Max	Min	Max				
SPST, OR	PE613010	Tuning Control	100	3000	70	–	38	0.20	0.80	4	11	2.3–5.5	7	2000	10L 2×2 QFN
SPDT, A/OR	PE42020	True DC	0 Hz	8000	62	36	38	0.6	1.1	34	48	11–15 ³	10	1000	20L 4×4 QFN
SPDT, A	PE42420 ⁴	High Isolation	100	6000	65	30	33	0.95	1.6	50	69	2.7–5.5	0.3	4000	20L 4×4 LGA
SPDT, A	PE42423	High Isolation	100	6000	65	36	39.5	0.8	0.95	41	51	2.3–5.5	0.5	3000	16L 3×3 QFN
SPDT, A	PE4251	Low Insertion Loss	10	4000	59	27	30.5	0.55	1.0	37	62	3.0–3.6	0.15	4000	8L MSOP
SPDT, A	PE42520	Broadband	0.009	13000	66	36	39	0.6	2.0	18	90	2.3–5.5	5.5	4000	16L 3×3 QFN
SPDT, A	PE42521	Broadband	0.009	13000	65	36	38	0.6	1.85	17	90	2.3–5.5	0.5	3000	16L 3×3 QFN
SPDT, A	PE42522	Broadband	0.009	26500	59	30	33	0.7	5.3	22	73	2.3–5.5	3	3500	29L 4×4 LGA
SPDT, A	PE42553	Broadband	0.009	8000	66	36	39	0.6	0.85	41	90	2.3–5.5	5.5	4000	16L 3×3 QFN
SPDT, A	PE4257	High Isolation	5	3000	55	33	31	0.75	1.2	44	64	2.7–3.3	2	1000	20L 4×4 QFN
SPDT, A	PE42822	High Power	700	3800	65	32	39.5	0.6	0.8	44	47	2.3–5.5	0.500	3000	16L 3×3 QFN
SPDT, R	PE423422 ⁴	Automotive	100	6000	73.5	32	34	0.25	0.9	16	41	2.3–5.5	2	1000	12L 2×2 QFN
SPDT, R	PE42359 ⁴	Automotive	10	3000	55	34	33.5	0.35	1.1	14	35	1.8–3.3	2	2000	6L SC70
SPDT, R	PE4239	Low Noise	10	3000	45	30	27	0.7	0.9	23	32	2.7–3.3	0.3	1500	6L SC70
SPDT, R	PE42421	Low Insertion Loss	10	3000	55	34	30.5	0.35	0.5	20	30	1.8–3.3	1.5	2000	6L SC70

General-purpose RF Switches (continued)

General-purpose RF Switches — 50Ω															
Product Description ¹	Part Number	Product Highlight	Operating Frequency (MHz)		IIP3 (dBm)	P _{max} CW (dBm)	P _{0.1dB} (dBm)	Insertion Loss (dB)		Isolation (dB)		V _{DD} Range (V)	Switching Time (μs) ²	ESD HBM (V)	Package
			Min	Max				Min	Max	Min	Max				
SPDT, R	PE42422	Low Insertion Loss	5	6000	75	32	34	0.23	0.9	17	68	2.3–5.5	2	4000	12L 2×2 QFN
SPDT, R	PE42424 ⁴	High Isolation, FS ⁵	100	6000	61	30	41	0.8	0.95	34	47	2.3–5.5	0.145	2500	6L 1.5×1.5 DFN
SPDT, R	PE42426	High Linearity	5	6000	83	33	40	0.3	0.75	20	33	2.3–5.5	35	3000	12L 3×3 QFN
SPDT, R	PE42427	Low Insertion Loss	5	6000	75	32	34	0.23	0.9	17	68	2.3–5.5	2	4000	12L 2×2 QFN
SPDT, R	PE4245	Low Insertion Loss	10	4000	45	30	27	0.6	0.7	32	42	2.7–3.3	0.2	1500	6L 3×3 DFN
SPDT, R	PE4250	Low Insertion Loss	10	3000	59	27	30.5	0.6	0.75	40	51	3.0–3.6	0.15	4000	8L MSOP
SPDT, R	PE42524	Wideband	10	40000	50	27	32.5	0.6	5.5	33	84	–	0.225	2000	Flip Chip
SPDT, R	PE42525	Wideband, FS ⁵	0.009	60000	46	29	35	0.9	2.7	36	80	–	0.008	1000	Flip Chip
SPDT, R	PE4259	Low Insertion Loss	10	3000	55	34	34	0.35	0.8	20	30	1.8–3.3	1.5	2000	6L SC70
SPDT, R	PE426525	Wideband, FS ⁵ , ET ⁶	0.009	60000	46	27	35	0.9	2.7	36	80	–	0.008	1000	Flip Chip
SPDT, R	PE42820	High Power	30	2700	85	43	45.5	0.3	0.7	24	35	2.3–5.5	15	1500	32L 5×5 QFN
SPDT, R	PE42821	High Power	100	2700	82	43	45.5	0.4	0.8	24	35	2.3–5.5	7	1500	32L 5×5 QFN
SPDT, R	PE42823	High Power 7W	700	6000	70	38.5	46	0.35	0.53	22	59	2.3–5.5	0.85	4500	16L 3×3 QFN
SP3T, R	PE42430	Low Insertion Loss	100	3000	66	27	30	0.45	0.55	30	40	3.0–5.5	0.500	4500	8L 1.5×1.5 DFN
SP4T, A	PE42441	Low Insertion Loss	10	8000	58	30	31	0.8	1.2	31	45	3.0–3.55	5	2000	32L 5×5 LGA
SP4T, A	PE42442 ⁴	High Isolation	30	6000	58	33	35	0.9	1.9	32	61	2.3–5.5	0.255	2000	24L 4×4 QFN
SP4T, A	PE42540	Broadband	0.00001	8000	58	30	33	0.7	1.2	27	84	3.0–3.6	5	2000	32L 5×5 LGA
SP4T, A	PE42542	Broadband	0.009	18000	58	30	33	0.7	3.1	27	90	2.3–5.5	3	3500	29L 4×4 LGA
SP4T, A	PE42543	Broadband	0.009	18000	59	30	33	0.7	3.2	29	90	2.3–5.5	0.5	2500	29L 4×4 LGA
SP4T, OR	PE613050	Tuning Control	5	3000	72	–	–	0.20	0.55	17	28	2.3–5.5	2	2000	12L 2×2 QFN
SP4T, R	PE423641 ⁴	Automotive	50	3000	68	35	37	0.5	0.95	22	32	2.65–3.3	1	2000	16L 3×3 QFN
SP4T, R	PE42440	Low Insertion Loss	50	3000	67	33	41.5	0.45	0.85	22	34	2.7–3.3	2	2000	16L 3×3 QFN
SP4T, R	PE42641	Low Insertion Loss	100	3000	68	35	–	0.45	0.55	27.5	35	2.65–2.85	2	2000	16L 3×3 QFN
SP5T, A	PE42451	High Isolation	450	4000	58	33	35	1.6	2.25	50	68	2.7–3.3	0.200	3500	24L 4×4 QFN
SP5T, A	PE42452 ⁴	High Isolation	450	4000	57	33	35	0.95	1.6	44	61	2.3–5.5	0.265	1500	24L 4×4 QFN
SP6T, A	PE42462 ⁴	Broadband, high ISO	10	8000	60	33	37.5	0.7	1.6	30	68	2.3–5.5	0.210	1000	24L 4×4 QFN
SP6T, A	PE42562 ⁴	Broadband, low IL	0.009	8000	60	33	37.5	0.7	1.6	30	68	2.3–5.5	0.210	1000	24L 4×4 QFN
SP6T, A	PE426462	Broadband, ET ⁶	10	8000	60	31	37.5	0.7	1.6	30	68	2.3–5.5	0.210	1000	24L 4×4 QFN
SP8T, A	PE42482 ⁴	Broadband, high ISO	10	8000	60	33	37.5	0.7	1.6	30	85	2.3–5.5	0.227	1000	24L 4×4 QFN
SP8T, A	PE42582 ⁴	Broadband, low IL	0.009	8000	60	33	37.5	0.7	1.6	30	85	2.3–5.5	0.227	1000	24L 4×4 QFN
SP8T, A	PE426482	Broadband, ET ⁶	10	8000	60	31	37.5	0.7	1.6	30	85	2.3–5.5	0.227	1000	24L 4×4 QFN
SP12T, A	PE42412 ⁴	Broadband, high ISO	10	8000	60	33	37.5	0.7	2.4	22	69	2.3–5.5	0.232	1000	32L 5×5 QFN
SP12T, A	PE42512 ⁴	Broadband, low IL	0.009	8000	60	33	37.5	0.7	2.4	22	69	2.3–5.5	0.232	1000	32L 5×5 QFN
SP12T, A	PE426412	Broadband, ET ⁶	10	8000	60	31	37.5	0.7	2.4	22	69	2.3–5.5	0.232	1000	32L 5×5 QFN
SP(3/5)T, R	PE42850	High Power	30	1000	42	42.5	45.5	0.25	0.35	30	36	2.3–5.5	15	1500	32L 5×5 QFN
SP(3/5)T, R	PE42851	High Power	100	1000	42	42.5	45.5	0.25	0.4	30	36	2.3–5.5	6	1500	32L 5×5 QFN
DDSPDT ⁷ , OR	PE42920	Differential	0.01	6000	50	10	13	0.7	3.1	26	30	2.97–3.63	0.270	2000	16L 3×3 QFN

Note 1: Absorptive (A), reflective (R) or open reflective (OR).

Note 2: 50% CTRL to 90% or 10% RF.

Note 3: Requires external negative voltage (V_{SS}, –11V to –15V) for operation. See datasheet for details.

Note 4: Operating temperature up to +105 °C.

Note 5: Fast switching (FS).

Note 6: Extended temperature (ET) range, –55 °C to +125 °C.

Note 7: Dual differential single pole double throw (DDSPDT).

75Ω
50Ω Our general-purpose reflective 50Ω switches can also be used in a 75Ω environment.

Test and Measurement Switches

The Peregrine RF product portfolio offers complementary devices for test equipment (TE) and automated test equipment (ATE) applications. Patented linearity technology enhancements reduce gate lag and insertion loss drift, while maintaining high linearity and isolation over an extended frequency range up to 60 GHz.

Test and Measurement Switches — 50Ω

Product Description ¹	Part Number	Operating Frequency (MHz)		Linearity IIP3/IIP2 (dBm)	P0.1dB (dBm)	Insertion Loss (dB)		Isolation (dB)		Settling Time (μs) ²	Switching Time (μs) ³	ESD HBM (V)	Package
		Min	Max			Min	Max	Min	Max				
SPDT, A	PE42520	0.009	13000	66 / 120	39	0.6	2.0	18	90	15	5.5	4000	16L 3x3 QFN
SPDT, A	PE42521	0.009	13000	65 / 120	38	0.6	1.85	17	90	2	0.5	3000	16L 3x3 QFN
SPDT, A	PE42522	0.009	26500	59 / 121	33	0.7	5.3	22	73	7	3	3500	29L 4x4 LGA
SPDT, A	PE42553	0.009	8000	66 / 120	39	0.6	0.85	41	90	15	5.5	4000	16L 3x3 QFN
SPDT, R	PE42524	10	40000	50 / -	32.5	0.6	5.5	33	84	0.84	0.225	2000	Flip Chip
SPDT, R	PE42525	0.009	60000	46 / 112	35	0.9	2.7	36	80	0.048	0.008	1000	Flip Chip
SP4T, A	PE42540	.00001	8000	58 / 100	33	0.7	1.2	27	84	15	5	2000	32L 5x5 LGA
SP4T, A	PE42542	0.009	18000	58 / 118	33	0.7	3.1	27	90	7	3	3500	29L 4x4 LGA
SP4T, A	PE42543	0.009	18000	59 / 113	33	0.7	3.2	29	90	2	0.5	2500	29L 4x4 LGA
SP6T, A	PE42562	0.009	8000	60 / 105	37.5	0.7	1.6	30	68	0.560	0.210	1000	24L 4x4 QFN
SP8T, A	PE42582	0.009	8000	60 / 105	37.5	0.7	1.6	30	85	0.870	0.227	1000	24L 4x4 QFN
SP12T, A	PE42512	0.009	8000	60 / 105	37.5	0.7	2.4	22	69	0.870	0.232	1000	32L 5x5 QFN

Note 1: Absorptive (A) or reflective (R).

Note 2: 50% CTRL to 0.05 dB final value.

Note 3: 50% CTRL to 90% or 10% RF.

Extended Temperature Switches

These switches are ideal for applications that require extended temperature support from -55 °C to +125 °C, such as harsh industrial applications.

Extended Temperature Switches — 50Ω

Product Description ¹	Part Number	Operating Frequency (MHz)		Linearity IIP3/IIP2 (dBm)	P0.1dB (dBm)	Insertion Loss (dB)		Isolation (dB)		Settling Time (μs) ²	Switching Time (μs) ³	ESD HBM (V)	Package
		Min	Max			Min	Max	Min	Max				
SPDT, R	PE426525	0.009	60000	46 / 112	35	0.9	2.7	36	80	0.048	0.008	1000	Flip Chip
SP6T, A	PE426462	10	8000	60 / 105	37.5	0.7	1.6	30	68	0.560	0.210	1000	24L 4x4 QFN
SP8T, A	PE426482	10	8000	60 / 105	37.5	0.7	1.6	30	85	0.870	0.227	1000	24L 4x4 QFN
SP12T, A	PE426412	10	8000	60 / 105	37.5	0.7	2.4	22	69	0.870	0.232	1000	32L 5x5 QFN

Note 1: Absorptive (A) or reflective (R).

Note 2: 50% CTRL to 0.05 dB final value.

Note 3: 50% CTRL to 90% or 10% RF.

High-frequency Examples: Breakthrough RF Performance Beyond 60 GHz

For additional information on optimizing high-frequency performance, please view application note AN42 and AN66 on www.psemi.com.

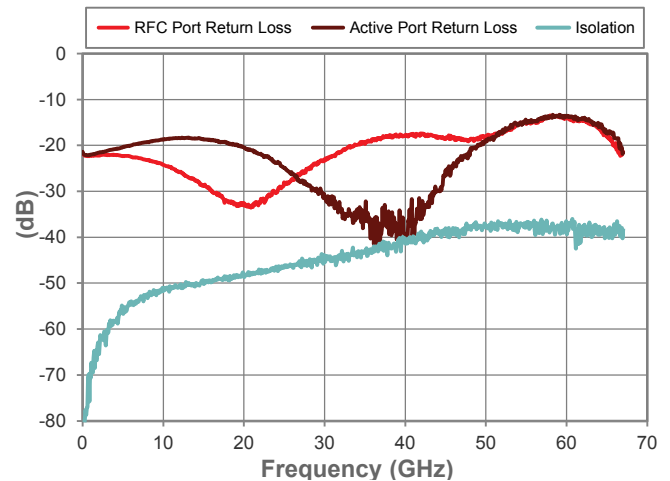
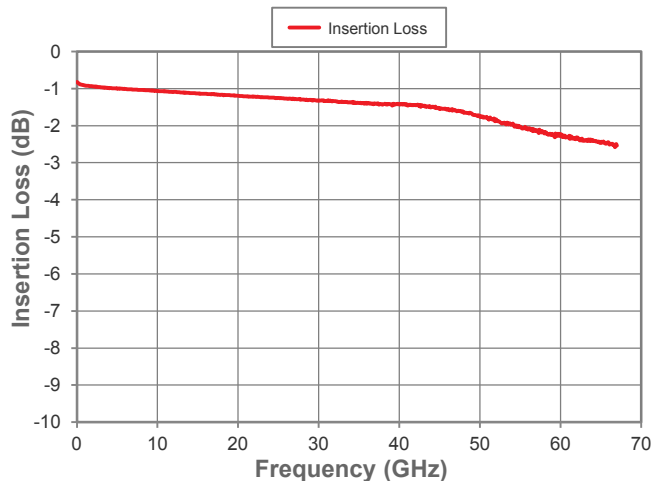

True DC RF Switch

The UltraCMOS PE42020 is the industry's first and only RF integrated switch to operate at zero Hz. This True DC RF switch features high power handling and maintains excellent RF performance and linearity from DC through 8000 MHz.

True DC RF Switch — 50Ω

Product Description	Part Number	Operating Frequency		Linearity IIP3/IIP2 (dBm)	P0.1dB (dBm)	Insertion Loss (dB)		Isolation (dB)		Settling Time (μs) ¹	Switching Time (μs) ²	ESD HBM (V)	Package
		Min	Max			Min	Max	Min	Max				
SPDT, A & OR ³	PE42020	0 Hz	8000 MHz	62 / 115	38	0.6	1.1	34	48	35	10	1000	20L 4×4 QFN

Note 1: 50% CTRL to 0.05 dB final value.
Note 2: 50% CTRL to 90% or 10% RF.

Note 3: Configurable 50Ω absorptive (A) or open reflective (OR) switch.

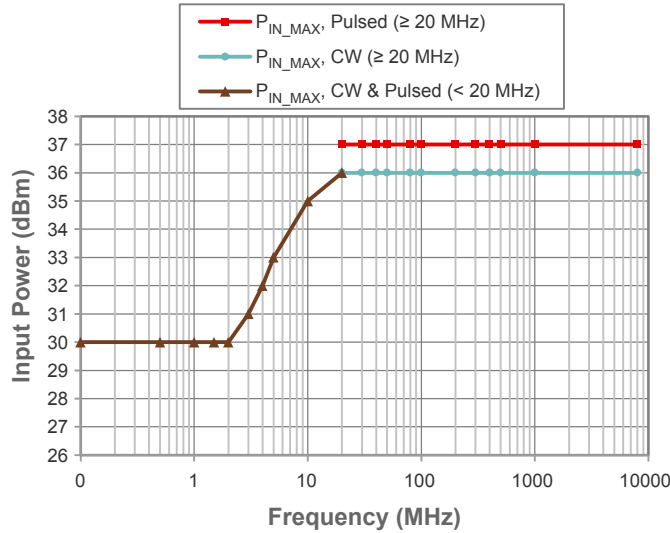

PE42020 Power Handling

The PE42020 exhibits high power handling of 30 dBm at 0 Hz and 36 dBm at 8 GHz. This graph shows the maximum RF input power (P_{IN_MAX}) for pulsed, CW and CW/pulsed at 0 °C to +85 °C ambient temperature, $V_{DD} = +15V$, and $V_{SS} = -15V$.

High-power RF Switches

UltraCMOS high-power switches change the paradigm of high-power switch design. These switches deliver a cost-effective, simple to design-in, long-term solution—a small footprint, monolithic, turnkey design with extremely low power consumption, excellent harmonic performance and high power handling.

High-power RF Switches — 50Ω

Product Description ¹	Part Number	Operating Frequency (MHz)		P0.1dB (dBm)	Insertion Loss (dB)		Isolation (dB)		RF Input Power, CW (dBm)	Linearity IIP3 (dBm)	ESD HBM (V)	Package
		Min	Max		Min	Max	Min	Max				
SPDT, R	PE42820	30	2700	45.5	0.3	0.7	24	35	43	85	1500	32L 5×5 QFN
SPDT, R	PE42821	100	2700	45.5	0.4	0.8	24	35	43	82	1500	32L 5×5 QFN
SPDT, A	PE42822	700	3800	39.5	0.6	0.8	41	47	32	66	3000	16L 3×3 QFN
SPDT, R	PE42823	700	6000	46	0.35	0.53	22	59	38.5	70	4500	16L 3×3 QFN
SP3T/SP5T, R	PE42850	30	1000	45.5	0.25	0.35	30	36	42.5	80	1500	32L 5×5 QFN
SP3T/SP5T, R	PE42851	100	1000	45.5	0.25	0.4	30	36	42.5	80	1500	32L 5×5 QFN

Note 1: Absorptive (A) or reflective (R).
Note 2: RX protection switch.

Automotive AEC-Q100 Certified Switches

These AEC-Q100 Grade 2 certified switches are capable of supporting operating temperatures up to +105 °C.

Automotive AEC-Q100 Certified Switches, Up to +105 °C

Product Description*	Part Number	Operating Frequency (MHz)		Linearity IIP3/IIP2 (dBm)	P0.1dB (dBm)	Insertion Loss (dB)		Isolation (dB)		Typical I _{DD} (µA @ 3V)	V _{DD} Range (V)	ESD HBM (V)	Package
		Min	Max			Min	Max	Min	Max				
SPDT, R	PE423422	100	6000	73.5 / 115	34	0.25	0.9	16	41	120	2.3–5.5	1000	12L 2×2 QFN
SPDT, R	PE42359	10	3000	55 / –	33.5	0.35	1.1	14	35	9	1.8–3.3	2000	6L SC70
SP4T, R	PE423641	50	3000	68 / 115	37	0.5	0.95	22	32	13	2.65–3.3	2000	16L 3×3 QFN

Note: * Reflective (R).

Wired Broadband 75Ω Switches

Simplify your next RF design with high-performance UltraCMOS 75Ω switches. Excellent isolation, low insertion loss and a CMOS/TTL compatible control address the needs of wired broadband applications.

Wired Broadband Switches — 75Ω¹

Product Description ²	Part Number	Product Highlight	Operating Frequency (MHz)		CTB/CSO (dBc)	P0.1dB (dBm)	Insertion Loss (dB)		Isolation (dB)		V _{DD} Range (V)	ESD HBM (V)	Package
			Min	Max			Min	Max	Min	Max			
SPST, A	PE4270	Low Insertion Loss	1	3000	–90 ³	30	0.5	0.7	63	90	2.7–3.3	500	6L 3×3 DFN
SPDT, A	PE4256	Low Insertion Loss	5	3000	–90 ³	31	0.5	1.1	52	80	2.7–3.3	1000	20L 4×4 QFN
SPDT, A	PE4280	High Isolation	5	2200	–85 ³	26	0.5	1.1	47	72	2.7–3.3	1000	20L 4×4 QFN
SPDT, A	PE42721	Low Insertion Loss	5	2200	–99 / <–105	27	0.4	0.65	55	85	2.3–5.5	3000	12L 3×3 QFN

Note 1: General-purpose, reflective 50Ω switches can also be used in a 75Ω environment.

Note 2: Absorptive (A) or reflective (R).

Note 3: CTB/CSO measured with 77 and 110 channels; PO = 44 dBmV.

DOCSIS 3.1/3.0 High Linearity Wired Broadband Switches — 75Ω¹

Product Description ²	Part Number	Operating Frequency (MHz)		Harmonics, fo = 17 MHz		P0.1dB (dBmV)	Insertion Loss (dB)		Isolation (dB)		V _{DD} Range (V)	ESD HBM (V)	Package
		Min	Max	2fo	3fo		Min	Max	Min	Max			
NEW SPDT, R	PE42422	5	6000	–92	–125	34	0.23	1.25	42	15	2.3–5.5	4000	12L 2×2 QFN
NEW SPDT, R	PE42427	5	6000	–92	–125	34	0.23	1.25	42	15	2.3–5.5	4000	12L 2×2 QFN
SPDT, R	PE42722	5	1794	–118	–140	88	0.2	0.85	29	50	2.3–5.5	1500	32L 5×5 QFN
SPDT, R	PE42723	5	1794	–121	–140	87	0.1	0.4	34	54	2.3–5.5	3000	12L 3×3 QFN
SPDT, R	PE42724	5	1794	–121	–150	87	0.1	0.4	19	39	2.3–5.5	2000	12L 3×3 QFN

Note 1: General-purpose, reflective 50Ω switches can also be used in a 75Ω environment.

Note 2: Reflective (R).

Wired Broadband Switches — 75Ω — With Unpowered Operation^{1,2}

Product Description ³	Part Number	Operating Frequency (MHz)		CTB/CSO (dBc)	P1dB ⁴ PWR/UNPWR (dBm)	Insertion Loss PWR (dB)		Isolation PWR/UNPWR (dB)		V _{DD} Range (V)	ESD HBM (V)	Package
		Min	Max			Min	Max	Min	Max			
SPDT, A	PE42742	5	2200	–90 / –77 ⁵	32 / 26.5	0.45	1.7	53 / 52.5	94 / 90.5	2.7–3.3	3500	20L 4×4 QFN
SPDT, A	PE42750	5	2200	–81 / –110 ⁶	23.5	0.7	1.7	57 / 72	84 / 90	2.7–3.6	2000	12L 3×3 QFN

Note 1: Unpowered state: PE42742: RFC–RF1 ON; PE42750: All ports terminated.

Note 2: General-purpose, reflective 50Ω switches can also be used in a 75Ω environment.

Note 3: Absorptive (A).

Note 4: Measured at 1 GHz.

Note 5: CTB/CSO measured with 77 and 110 channels; PO = 44 dBmV.

Note 6: CTB/CSO measured with 159 channels; PO = 42 dBmV.

75Ω
50Ω Our general-purpose reflective 50Ω switches can also be used in a 75Ω environment.

Glitch-less Digital Step Attenuators (DSA)

These glitch-less DSAs feature a novel architecture to provide the best-in-class glitch-less transition behavior when changing attenuation states and are specified to support temperatures up to +105 °C.

Glitch-less Digital Step Attenuators (Monolithic) — 50Ω, Up to +105 °C

Product Description, Part Number	Attenuation (dB) (Range/Min. Step Size)	Programming Mode	Operating Frequency (MHz)		Insertion Loss (dB)		Input IP3 (dBm)	Attenuation Accuracy (dB @ 2.2 GHz)	Switching Time (ns)	ESD HBM (V)	Package
			Min	Max	Min	Max					
7-bit – PE43711	0.25–31.75 / 0.25	Parallel ¹ , Serial	0.009	6000	1.3	2.4	57	±(0.15 + 1.5% of setting)	275	3000	24L 4×4 QFN
7-bit – PE43712	0.25–31.75 / 0.25	Parallel ¹ , Ser-Add ²	0.009	6000	1.3	2.45	57	±(0.20 + 1.5% of setting)	275	3000	32L 5×5 QFN
7-bit – PE43713 ³	0.25–31.75 / 0.25	Parallel ¹ , Ser-Add ²	0.009	6000	1.3	2.45	57	±(0.20 + 1.5% of setting)	275	3000	32L 5×5 QFN

Note 1: Parallel modes: latched and direct.

Note 2: Serial-addressable mode.

Note 3: External V_{SS} option.

Glitch-less Digital Step Attenuator (Monolithic) — 75Ω, Up to +105 °C

Product Description, Part Number	Attenuation (dB) (Range/Min. Step Size)	Programming Mode	Operating Frequency (MHz)		Insertion Loss (dB)		Input IP3 (dBm)	Attenuation Accuracy (dB @ 1.2 GHz)	Switching Time (ns)	ESD HBM (V)	Package
			Min	Max	Min	Max					
6-bit – PE4314 ¹	0.5–31.5 / 0.5	Parallel ² , Serial	1	2500	1	1.5	58	±(0.15 + 3% of setting)	370	1500	20L 4×4 QFN

Note 1: External V_{SS} option.

Note 2: Parallel modes: latched and direct.

50Ω Digital Step Attenuators

Digital Step Attenuators (Monolithic) — 50Ω

Product Description, Part Number	Attenuation (dB) (Range/Min. Step Size)	Programming Mode	Operating Frequency (MHz)		Insertion Loss (dB)		Input IP3 (dBm)	Attenuation Accuracy (dB @ 1 GHz)	Switching Time (μs)	ESD HBM (V)	Package
			Min	Max	Min	Max					
2-bit – PE43205 ¹	6–18 / 6	Parallel	35	6000	0.5	1.05	61	+0.10	0.031	2000	12L 3×3 QFN
NEW 2-bit – PE43620	0–18 / 6, 12, and 18	Parallel ³	50	3000	0.6	0.7	61	±(–0.25/+0.40 of setting)	0.03	2000	12L 3×3 QFN
NEW 5-bit – PE43650	0–15.5 / 0.5	Parallel ³ , Serial	0.009	6000	2.4	2.9	58	±(0.3/+0.30 of setting)	4	500	24L 4×4 QFN
6-bit – PE4312 ^{1,2}	0.5–31.5 / 0.5	Parallel ³ , Serial	1	4000	1.3	2.1	59	±(0.15 + 2% of setting)	0.5	1500	20L 4×4 QFN
NEW 6-bit – PE43508 ^{1,2}	0.5–31.5 / 0.5	Par ³ , Ser, Ser-Add ⁴	0.009	55000	2.2	5.9	50	±(1.00 + 4.5% of setting) –1	0.330	1000	Flip Chip
NEW 7-bit – PE43670	0–31.75 / 0.25	Parallel ³ , Ser-Add ⁴	0.009	4000	1.9	2.4	59	±(0.2/+0.15 of setting)	4	500	32L 5×5 QFN
7-bit – PE43704 ²	0.25–31.75 / 0.25	Par ³ , Ser, Ser-Add ⁴	0.009	8000	1.3	2.9	61	+(0.15 + 4.5% of setting) –(0.1 + 2% of setting)	1.1	1500	32L 5×5 QFN
7-bit – PE43705 ^{1,2}	0.25–31.75 / 0.25	Par ³ , Ser, Ser-Add ⁴	50	8000	1.3	2.4	58	+(0.15 + 1.5% of setting) –(0.1 + 1% of setting)	1	1500	32L 5×5 QFN

Note 1: Operating temperature up to +105 °C.

Note 2: Glitch-safe: negative glitch only.

Note 3: Parallel modes: latched and direct.

Note 4: Serial-addressable mode.

75Ω Digital Step Attenuators

Digital Step Attenuators (Monolithic) — 75Ω

Product Description, Part Number	Attenuation (dB) (Range/Min. Step Size)	Programming Mode	Operating Frequency (MHz)		Insertion Loss (dB)		Input IP3 (dBm)	Attenuation Accuracy (dB @ 1 GHz)	Switching Time (μs)	ESD HBM (V)	Package
			Min	Max	Min	Max					
NEW 6-bit – PE43665	0–31.5 / 0.5	Parallel ¹ , Serial	1	2000	1.4	1.8	52	±(0.15 + 4% of setting)	1	500	20L 4×4 QFN

Note 1: Parallel modes: latched and direct.

Monolithic Phase and Amplitude Controller (MPAC) Devices

As well as being ideal for Doherty power amplifier architectures, other products in the MPAC family are ideal for beamforming, full wireless duplex and 5G by enhancing system performance, lowering bill of material (BoM) costs, increasing reliability and providing maximum tuning flexibility.

MPAC-Doherty — 50Ω												
Product Description, Part Number	Phase (°) (Range/Steps) 5 bits	Attenuation (dB) (Range/Steps) 4 bits	Programming Mode	Operating Frequency (GHz)		Insertion Loss (dB)	Input IP3 (dBm)	P0.1dB (dBm)	V _{DD} Range (V)	I _{DD} (μA)	ESD HBM (V)	Package
				Min	Max							
5/4-bit – PE46120	-87.2 / 2.8	7.5 / 0.5	Serial	1.8	2.2	6.9	60	35	2.3–5.5	350	1000	32L 6×6 QFN
5/4-bit – PE46130	-87.2 / 2.8	7.5 / 0.5	Serial	2.3	2.7	7.2	70	35	2.3–5.5	350	1500	32L 6×6 QFN
5/4-bit – PE46140	-87.2 / 2.8	7.5 / 0.5	Serial	3.4	3.8	6.5	60	35	2.3–5.5	350	1500	32L 6×6 QFN

Relative Phase RF_{IN} to RF_{OUT} (All Phase States)

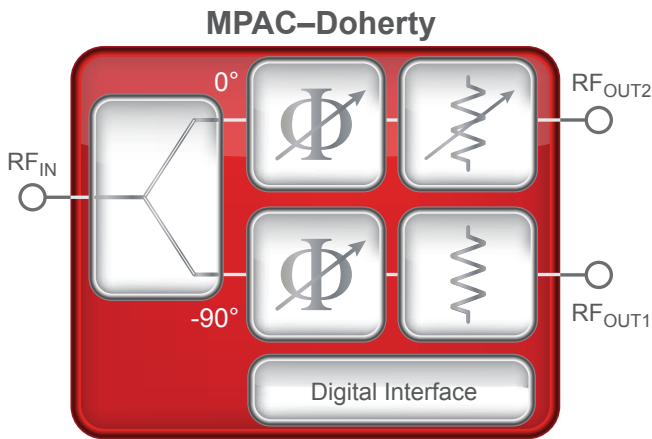

Pin-compatible MPAC—Doherty Family

These devices are highly monotonic over a broad frequency range for all RF_{OUT1} / RF_{OUT2} phase states.

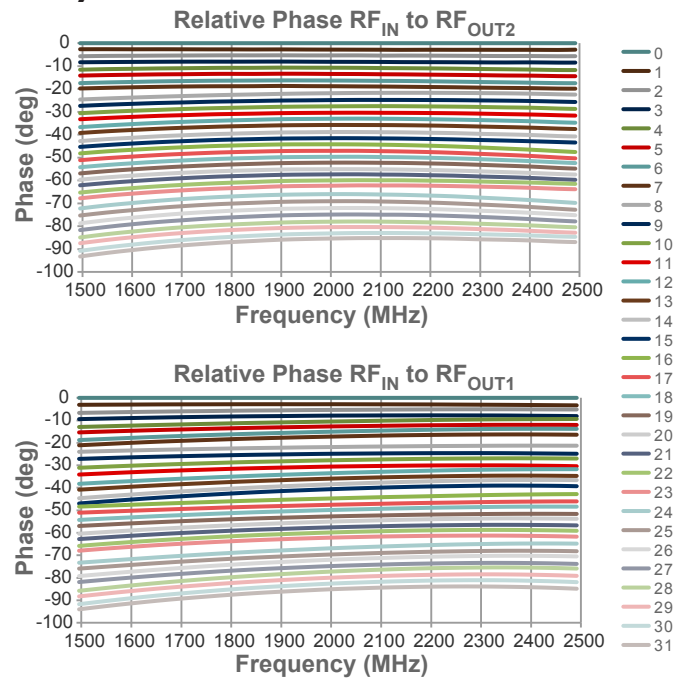

Phase Variation Across Atten State

Excellent phase stability across all RF_{OUT} attenuation states.

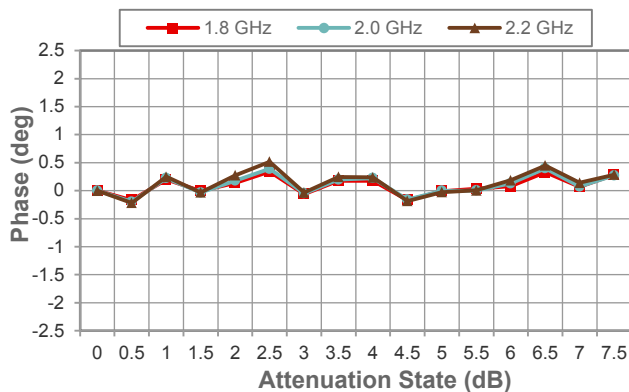

Isolation Output Ports (All States)

High isolation across all phase and attenuation states.

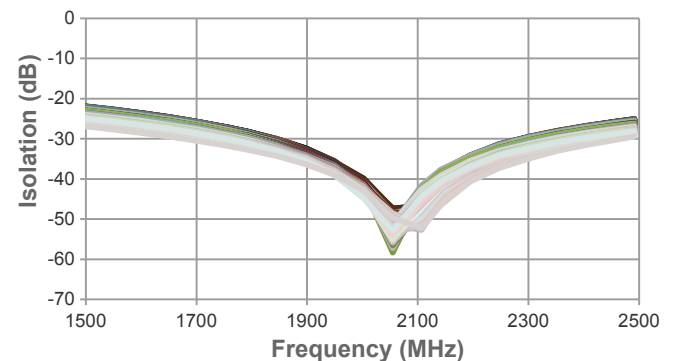

Switch + LNAs

pSemi's switch + low-noise amplifier (LNA) modules provide highly-integrated, low-power solutions ideal for 5G multiple-input, multiple-output (MIMO) base stations. With an ultra-low noise figure, excellent input power handling, superior ESD robustness, and small solution size, these modules are ideal for protecting remote radio units that operate in the sub-6 GHz frequency bands.

Switch + LNAs								
Part Number	Configuration	Frequency (GHz)	Noise Figure (dB)	OIP3 (dBm)	Gain (dB)	Supply Current per Channel (mA)	ESD HBM (V)	Package
NEW PE53110	Single-channel	3.3–3.8	1.65	29	32	90	1000	32L 5×5 LGA
NEW PE53210	Dual-channel	3.3–3.8	1.65	29	32	90	1000	32L 5×5 LGA
NEW PE53111	Single-channel	2.3–2.7	1.45	30	34	90	1000	32L 5×5 LGA
NEW PE53211	Dual-channel	2.3–2.7	1.45	30	34	90	1000	32L 5×5 LGA

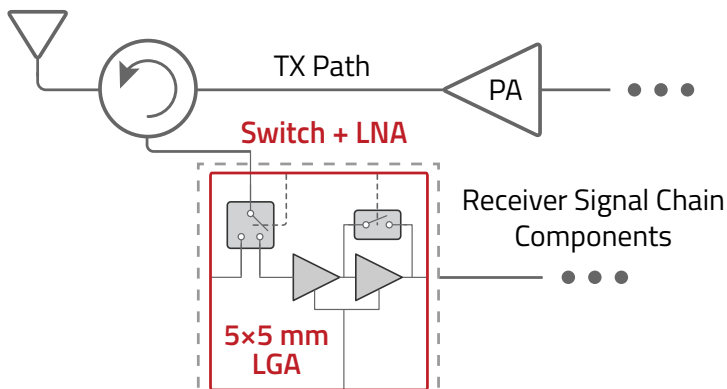

A Powerful Solution

pSemi's UltraCMOS switch + LNA modules provide a powerful advantage over competing PIN-diode solutions, including

- 60% smaller solution size
- 25% lower power consumption
- no external RF matching components
- superior ESD robustness
- lower cost of implementation

Power Limiting Devices

UltraCMOS power limiters deliver simple, repeatable and reliable protection, ideal for test-and-measurement (T&M), land-mobile-radio (LMR), wireless infrastructure, military and radar systems in the industry's first turnkey, monolithic solutions.

Power Limiters									
Part Number	Operation Modes	Operating Frequency	Adjustable Power Limiting Threshold (dBm)	Max Power Handling (dBm)		Input IP3 (dBm)	Control Voltage Range (V)*	ESD HBM (V)	Package
				Pulsed	CW				
PE45140	Limiting, Reflecting	20–2000 MHz	22–32	47	40	64	–2.5 to –0.5	8000	12L 3×3 QFN
PE45361	Limiting, Reflecting	10 MHz–6 GHz	7–13	50	36	37	0 to 0.3	7000	12L 3×3 QFN
PE45450	Limiting, Reflecting	9 kHz–6 GHz	25–35	47	40	70	–2.5 to –0.5	8000	12L 3×3 QFN

Note: * Limiting mode.

Replacing PIN-Diode Solutions

An UltraCMOS power-limiting device is up to eight times smaller than traditional discrete PIN-diode solutions and offers better linearity, versatility and reliability.

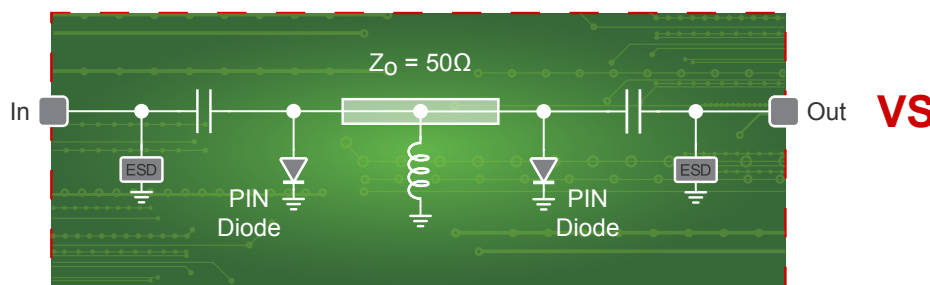

Discrete PIN-diode Solution



UltraCMOS Solution: up to **8x smaller** while maintaining the same power dissipation

Mixers

UltraCMOS mixers are broadband, quad metal-oxide-semiconductor field-effect transistor (MOSFET) array cores. The integrated receive mixers feature high linearity, image rejection, local oscillator (LO) isolation, strong low-frequency performance, monolithic integration and high reliability, making them easier to implement and more dependable than GaAs-based MOSFET arrays.

Mixer Core										
Part Number	Operating Frequency (MHz)			LO Drive (dBm)	Conv Loss (dB)	Isolation (dB, typ)		Input IP3 (dBm, typ)	ESD HBM (V)	Package
	LO	RF	IF, Nom			LO–RF	LO–IF			
PE4140 ^{1,2}	0.01–6000	0.01–6000	0.01–6000	0 to +20	6.5–7.5	25–40	25–40	36	100	6L 3×3 DFN
PE4141 ^{1,2,3}	0.01–1000	0.01–1000	0.01–1000	0 to +20	7.0–8.0	40	40	33	100	8L MSOP
PE4151 ^{1,3}	245–410	136–520	44.85–109.65	–10 to –6	6.5–8.5	43	40	26	1000	10L MSOP
PE4152 ¹	245–831	136–941	109.65	–10 to +23	6.5–7.5	30–60	22–58	26	1000	20L 4×4 QFN

Note 1: Fully differential DC coupled ports. External baluns required.

Note 3: Low magnetic.

Note 2: Quad MOSFET array.

Digital Phase Shifter

Get flexibility for the most design-stringent requirements with high linearity, excellent harmonic performance, extended phase range, high resolution, low RMS phase and amplitude error and dual-programming options.

Digital Phase Shifter (Monolithic) — 50Ω, Up to +105 °C											
Part Number	Operating Frequency (GHz)	Bit #	Range (°)	Resolution (°)	Insertion Loss (dB)	RMS Phase Error (°)	RMS Amplitude Error (dB)	Settling Time (ns)	V _{DD} Range (V)	ESD HBM (V)	Package
PE44820 *	1.7–2.2	8	358.6	1.4	6	1.0	0.1	365	2.3–5.5	500	32L 5×5 QFN

Note: * With extended frequency support from 1–3 GHz.

Prescaler

Prescalers divide the frequency of a wireless signal to extend the operating range of a phase-locked loop (PLL) beyond its base capability. UltraCMOS prescalers enable exceptional low phase noise performance in C, X and Ku frequency bands while consuming extremely low power.

Prescaler						
Part Number	Type	Description	Operating Frequency (MHz)		ESD HBM (V)	Package
			Min	Max		
PE35400	Divide by 4	Low Power	3000	13500	250	DIE

Wi-Fi Front-end Modules

Ideal for Wi-Fi home gateways, routers and set-top boxes, this high-performance module uses a smart linear compensation technique to deliver a high linearity signal and excellent long-packet error vector magnitude (EVM) performance.

Wi-Fi FEMs						
Part Number	Frequency (GHz)	Transmit Gain (dB)	Receive Gain (dB)	Long-packet EVM Performance	Temperature Range	Package
NEW PE561221	2.4–2.5	28	14	+19 dBm P _{OUT} at –40 dB EVM (MCS9)	–40 to +85 °C	16L 2×2 LGA

Digital Tuning Solutions

In complex radio designs where detuning can cause increased filter loss, power amplifier (PA) inefficiencies and antenna mismatch, signal-chain performance can be significantly improved with a monolithically integrated solid-state impedance tuning solution. Our digitally tunable capacitor (DTC) and tunable control switch products continue a tradition of innovation, high performance and ease-of-use by offering tunability, high-voltage handling and excellent linearity.

Digitally Tunable Capacitors

Part Number	Interface	Operating Frequency (MHz)		Min Shunt Capacitance (pF)	Max Shunt Capacitance (pF)	Tuning Ratio (Shunt)	Quality Factor (Shunt, 1 GHz)		Peak Operating Voltage (V _{PK})	V _{DD} Range (V)	ESD HBM (V)	Package
		Min	Max				C _{min}	C _{max}				
PE64102	SPI	100	3000	1.88	14	7.4:1	50	20	6	2.3–3.6	2000	12L 2x2 QFN
PE64904	SPI	100	3000	1.10	5.10	4.6:1	35	25	30	2.3–3.6	1500	10L 2x2 QFN
PE64906	SPI	100	3000	0.90	4.60	5.1:1	40	29	30	2.3–4.8	2000	10L 2x2 QFN
PE64907	SPI	100	3000	0.85	2.40	2.82:1	40	34	30	2.3–4.8	2000	10L 2x2 QFN
PE64909	SPI	100	3000	0.60	2.35	3.9:1	40	29	30	2.3–4.8	2000	10L 2x2 QFN

Tuning Control Switches

Product Description*	Part Number	Operating Frequency (MHz)		Interface	R _{ON} (Ω)	C _{OFF} (pF)	Peak RF Voltage (V _{pk})	V _{DD} Range (V)	ESD HBM (V)	Package
SPST	PE613010	100	3000	GPIO	1.2	0.40	25	2.3–5.5	2000	10L 2x2 QFN
SP4T	PE613050	5	3000	GPIO	1.6	0.14	18	2.3–5.5	2000	12L 2x2 QFN

Note: * Open reflective switches.

Antenna Impedance Tuning

The DTC tuner increases power delivered to the antenna by eliminating mismatch loss.

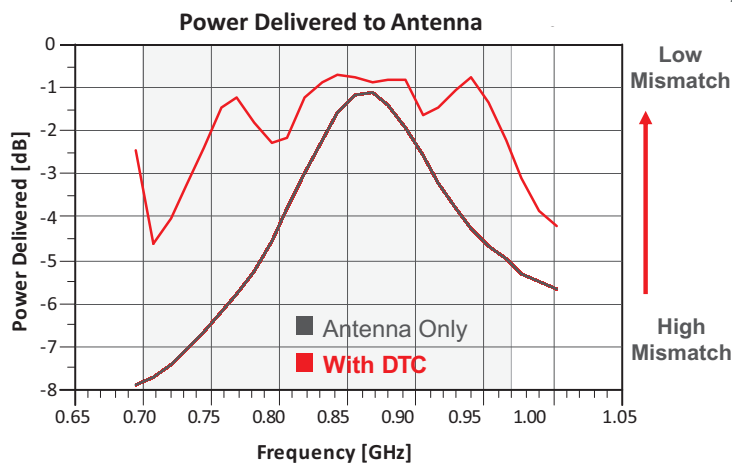

Tunable Matching Networks

Match the desired impedance to 50Ω or other impedance over broadband (700–2200 MHz) to minimize mismatch loss.

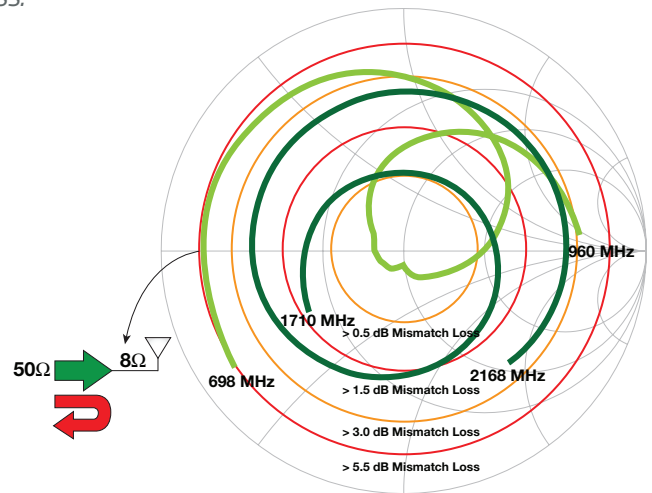

Quality and Reliability

We are committed to providing high-quality products and services that meet or exceed our customers' expectations. We have developed and implemented a quality management system to create an organizational environment designed to meet the highest level of quality and reliability standards. Our quality management system has been certified and

maintained to ISO 9001:2015, AS9100D aerospace standard and IATF 16949:2016 automotive standard. Additionally, pSemi Corporation's automotive products are qualified using the requirements in AEC Q100. pSemi Corporation is a member company of the Automotive Electronics Council (AEC).

Technology Advantages

UltraCMOS Technology and Intelligent Integration

UltraCMOS products feature intelligent integration—the ability to integrate RF, digital and analog components on a single die. With intelligent integration, a single chip can integrate features

such as analog DC tracking, digital logic control, high-performance switching, phase shifters and digital step attenuators.

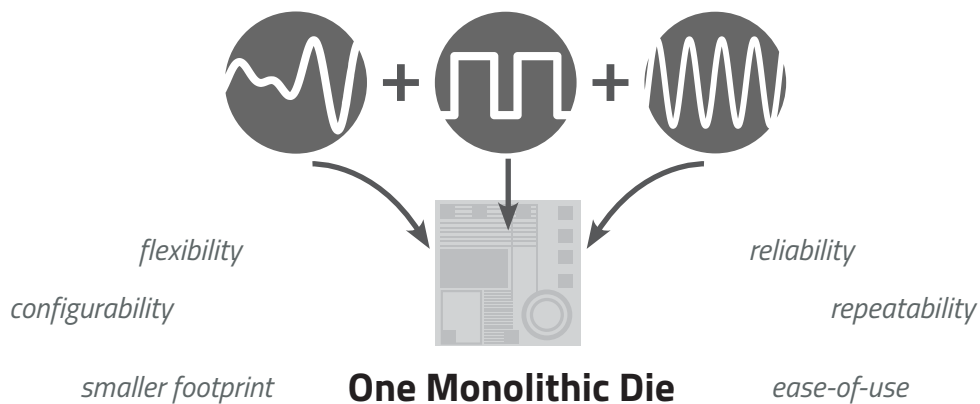

HaRP™ Technology

UltraCMOS® technology is composed of stack of field effect transistors manufactured on an insulating substrate, providing the ability to pass high-power RF signals. The HaRP invention allows for very linear FETs that when stacked together provide excellent linear performance.

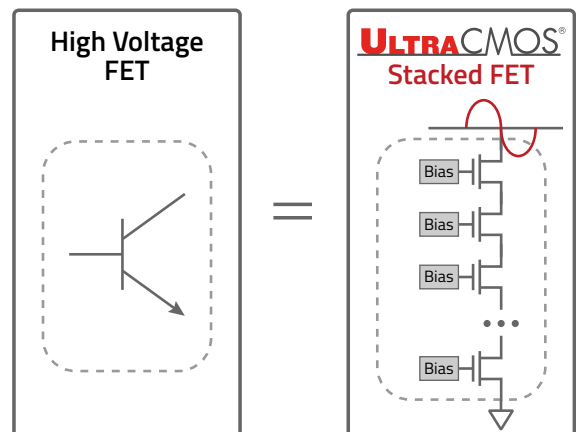

FET stacking is a very efficient way to handle power using low voltage devices

ULTRACMOS[®] GREEN

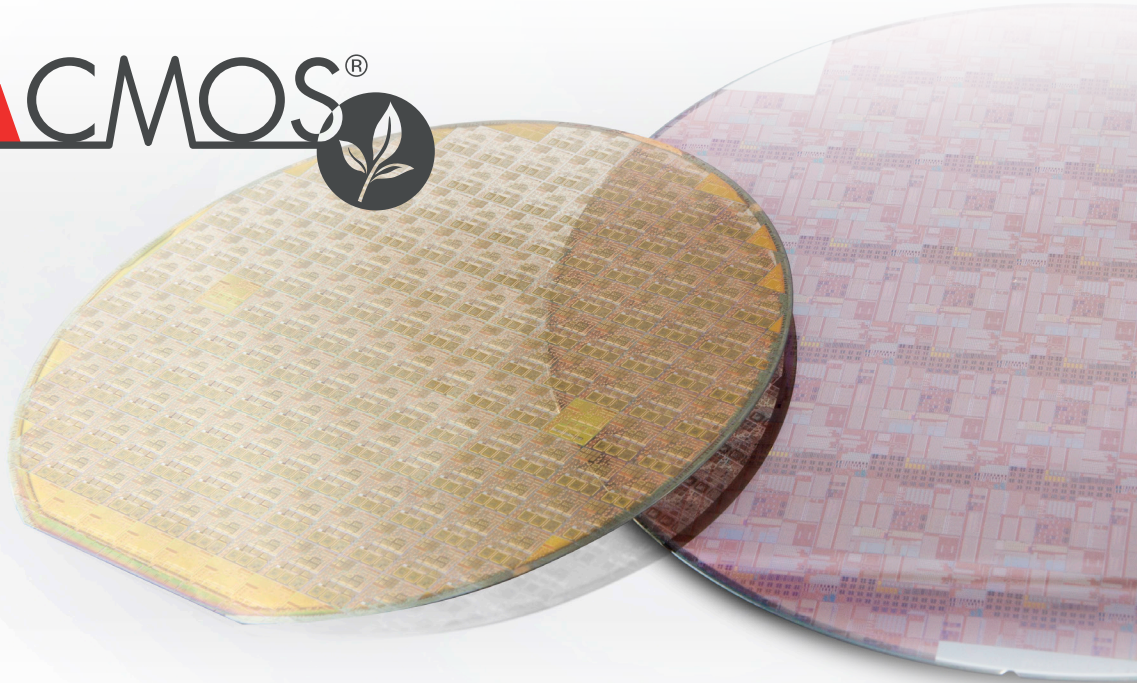

Going Green Starts on the Inside

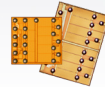

The UltraCMOS process is a high-performance variation of SOI that incorporates a sapphire or silicon substrate. These substrates intrinsically offer both environmental as well as RF benefits.

Visit psemi.com to learn more about the materials used to produce our wafers and any other packaging information you need.

RoHS-compliant Commercial Packaging Options

 6L SC70 1.3 × 2.0 × 1.0	 8L 1.5×1.5 DFN 1.5 × 1.5 × 0.50	 10L 2×2 QFN 2.0 × 2.0 × 0.45	 12L 2×2 QFN 2.0 × 2.0 × 0.60	 8L MSOP 3.0 × 3.0 × 1.1	 10L MSOP 3.0 × 3.0 × 0.86	 6L DFN 3.0 × 3.0 × 0.9
 12L 3×3 QFN 3.0 × 3.0 × 0.75	 16L 3×3 QFN 3.0 × 3.0 × 0.75	 20L 4×4 LGA 4.0 × 4.0 × 0.9	 20L 4×4 QFN 4.0 × 4.0 × 0.9	 24L 4×4 QFN 4.0 × 4.0 × 0.9	 24L 4×4 LGA 4.0 × 4.0 × 0.9	
 29L 4×4 LGA 4.0 × 4.0 × 0.9	 32L 5×5 QFN 5.0 × 5.0 × 0.9	 32L 5×5 LGA 5.0 × 5.0 × 0.9	 32L 6×6 QFN 6.0 × 6.0 × 0.9			

All dimensions are listed in millimeters (width × length × height) and are approximate. See product datasheets for exact dimensions.



Design and Application Support

Designing for tomorrow's challenging RF applications requires high-performance products and outstanding technical support. From our engineering excellence to streamlined manufacturing and technical sales and applications support, our team is committed to providing a complete product solution. Choose among our comprehensive library of datasheets, application notes, tutorials, reference designs and other engineering resources, all developed to help get your design to market on time.

Online Support System support.psemi.com

Visit our website to find the technical resources you need.



©2019 pSemi Corporation. All right reserved. The Peregrine Semiconductor name, logo and UltraCMOS are registered trademarks, and pSemi is a trademark of pSemi Corporation. All other trademarks are the property of their respective owners. All information on these pages are subject to change without notice. Consult website for latest specifications. pSemi products are protected under one or more of the following U.S. patents: <http://patents.psemi.com>

DOC-94007-18 Web Version
05/2019

Sales Offices

The Americas

pSemi Corporation
9369 Carroll Park Drive
San Diego, CA, USA 92121
Phone: +1-858-731-9400
Fax: +1-858-731-9499
Email: Sales@psemi.com

Europe

pSemi Europe
1420 Arlington Park
Theale, Berkshire RG7 4SA
United Kingdom
Phone +44-118-3340-7693
Email: Sales@psemi.com

Asia Pacific

pSemi China
14B
918 Middle Huaihai Road
Shanghai, China, 200020
Phone +86-21-5836-8276
Fax +86-21-5836-8550
Email:
Sales_NorthChina@psemi.com
Sales_SouthChina@psemi.com

pSemi Korea
C-3004 Kolon Tripolis
1, Jeongjail-ro
Bundang-gu, Seongnam-si
South Korea, 13616
Phone: +82-31-728-3939
Fax: +82-31-728-3940
Email: Sales_Korea@psemi.com

pSemi Taiwan
Master International Business Centre
10F, No. 209, Section 1, Civic Blvd
Datong District, Taipei 103
Taiwan
Phone +886-2-21811699
Fax +886-2-21811669

psemi.com

