

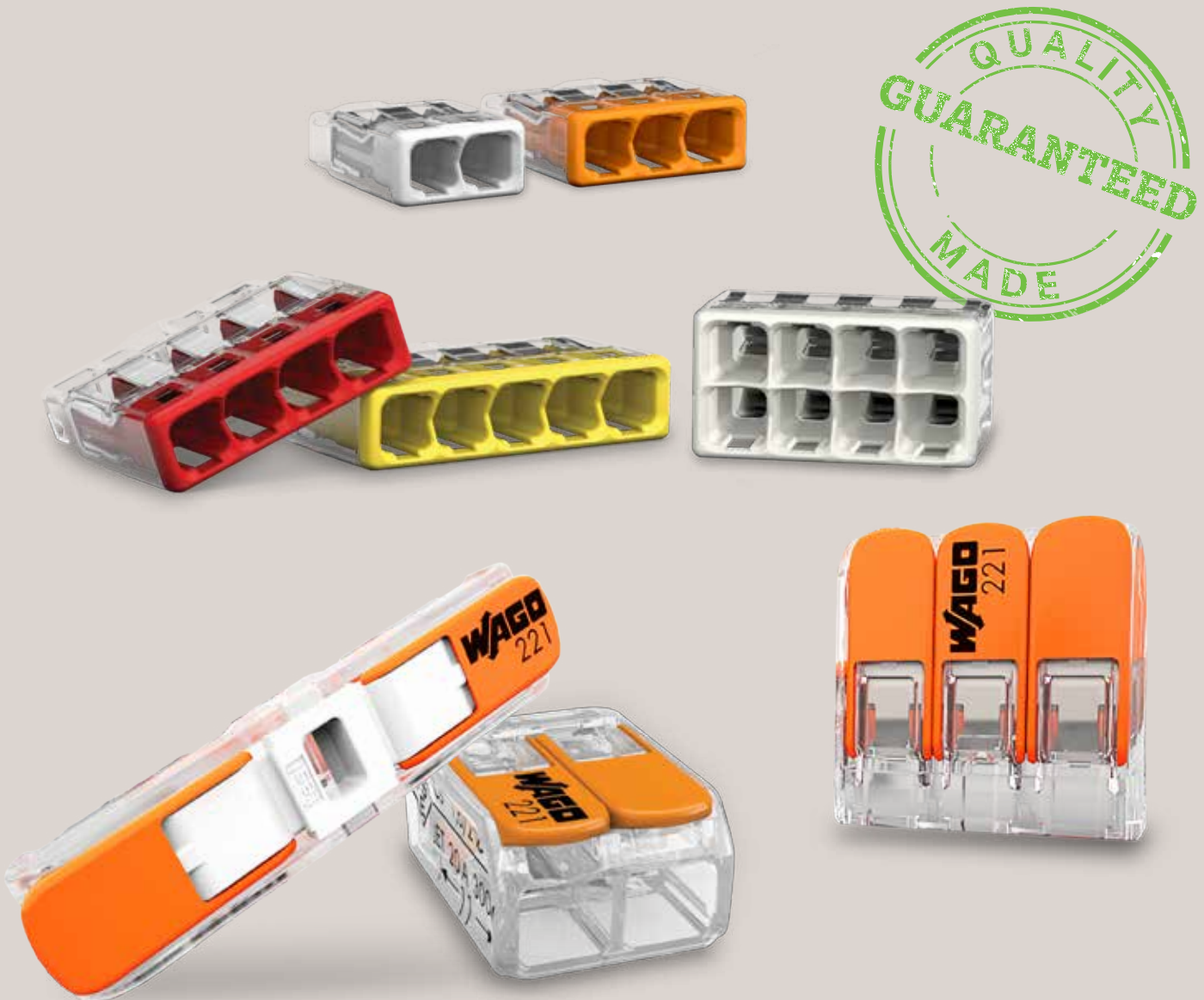

ELECTRICAL INSTALLATION PRODUCTS

Splicing Connectors and Chassis Mount Terminal Blocks





Contents

221 Series LEVER-NUTS® 12 AWG, 10 AWG, Hazardous Locations, Inline	4 – 9
222 Series LEVER-NUTS® The Original Lever-Operated Splicing Connector	10 – 11
Accessories For 221 Series and 222 Series	12 – 13
2773 Series WALL-NUTS® PUSHWIRE® Connectors for Junction Boxes	14 – 15
224 Series Inline Connectors	16 – 17



243 Series MICRO PUSHWIRE® Connectors	18 – 19
873 Series PUSHWIRE® Connectors for Luminaire Disconnect	20 – 21
862 Series Chassis Mount Terminal Blocks	22 – 25
Accessories and Operating Tools Operating Tools, Stripping, Cutting, and Crimping Tools, Ferrules, Test and Measurement Devices	26 – 31





221 SERIES LEVER-NUTS®

Compact Splicing Connectors for All Wire Types



221 SERIES LEVER-NUTS®

- Connect any combination of solid, stranded and flexible copper wires quickly and reliably
- Visually inspect for proper strip length and complete wire insertion through its transparent housing
- Operate comfortably and with lower operating forces by using familiar orange levers

Electrical Data	12 AWG	10 AWG
Rated voltage	600 V (1000 V signs & fixtures)	
Nominal current	20 A	30 A
Wire Size		
Solid conductor	24 - 12 AWG	20 - 10 AWG
Stranded conductor	24 - 12 AWG	20 - 10 AWG
Flexible conductor	24 - 12 AWG	20 - 10 AWG
Strip length	11 mm / 0.43 in.	13 mm
Maximum operating temperature	105 °C	
Approvals	    	

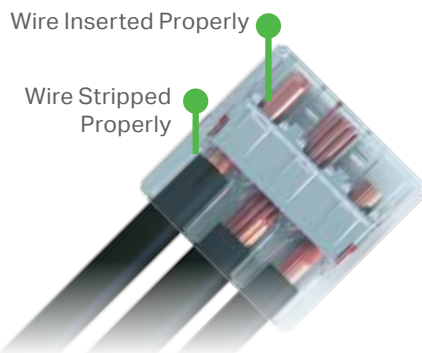
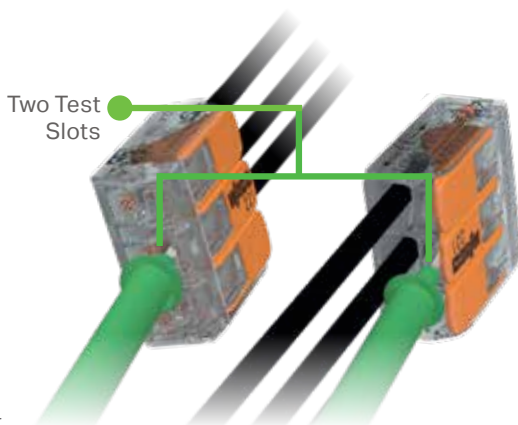

Easily combine various types and sizes of wires

- 12 AWG family: 24 - 12 AWG
- 10 AWG family: 20 - 10 AWG

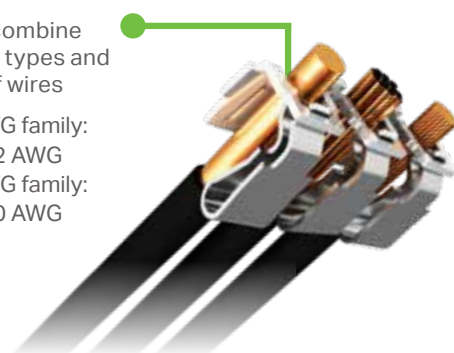

221 Series for 12 AWG

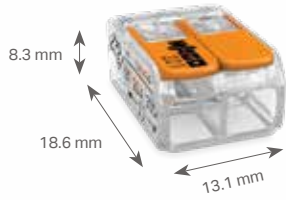

L 11 mm / 0.43 in.

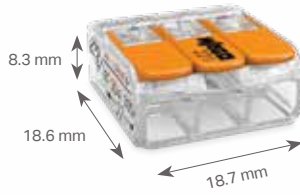

L 11 mm / 0.43 in.



L 11 mm / 0.43 in.

2-conductor connector Transparent housing, orange levers		3-conductor connector Transparent housing, orange levers		5-conductor connector Transparent housing, orange levers	
Item No.	Pack.-unit pcs	Item No.	Pack.-unit pcs	Item No.	Pack.-unit pcs
221-412	1=box of 100 pcs	221-413	1=box of 50 pcs	221-415	1=box of 25 pcs
221-412/VE00-2500	2500 (bulk)	221-413/VE00-2500	2500 (bulk)	221-415/VE00-1000	1000 (bulk)
221-412/996-010	1=10 (clamshell)	221-413/996-010	1=10 (clamshell)	221-415/996-010	1=10 (clamshell)
221-412/K194-4045/000-100	1=jug of 550	221-413/K194-4045/000-100	1=jug of 350	221-415/K194-4045/000-100	1=jug of 225

221 Series for 10 AWG

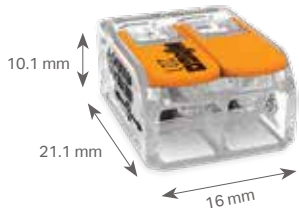

L 11 mm / 0.43 in.



L 11 mm / 0.43 in.

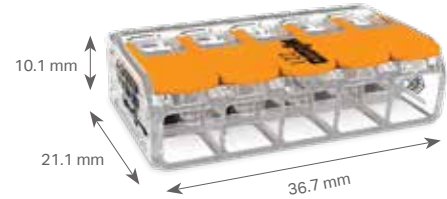

L 11 mm / 0.43 in.

2-conductor connector Transparent housing, orange levers		3-conductor connector Transparent housing, orange levers		5-conductor connector Transparent housing, orange levers	
Item No.	Pack.-unit pcs	Item No.	Pack.-unit pcs	Item No.	Pack.-unit pcs
221-612	1=box of 50 pcs	221-613	1=box of 30 pcs	221-615	1=box of 15 pcs
221-612/VE00-1000	1000 (bulk)	221-613/VE00-1000	1000 (bulk)	221-615/VE00-500	500 (bulk)



221 SERIES *LEVER-NUTS*[®] INLINE

Compact Splicing Connectors for All Wire Types



221 SERIES *LEVER-NUTS*[®] INLINE

- Connects solid, stranded and fine-stranded conductors from 20-12 AWG in the feedthrough direction
- Slim design minimizes dimensions for installation in tight spaces
- Ease of use - lift the lever up, insert a conductor and push the lever back down
- Tool-free connection and disconnection thanks to the convenient lever technology

Electrical Data	
Item Number: 221-2401	
Rated voltage	600 V (1000 V signs & fixtures)
Nominal current	20 A
Wire Size	
Solid conductor	20 - 12 AWG
Stranded conductor	18 - 12 AWG
Flexible conductor	18 - 12 AWG
Strip length	11 mm / 0.43 in.
Maximum operating temperature	105 °C
Approvals	  

2-conductor connector
Transparent housing, orange levers

Item No.	Pack.-unit pcs
221-2401	1=box of 60 pcs
221-2401	500 (bulk)
221-2401	2500 (bulk)

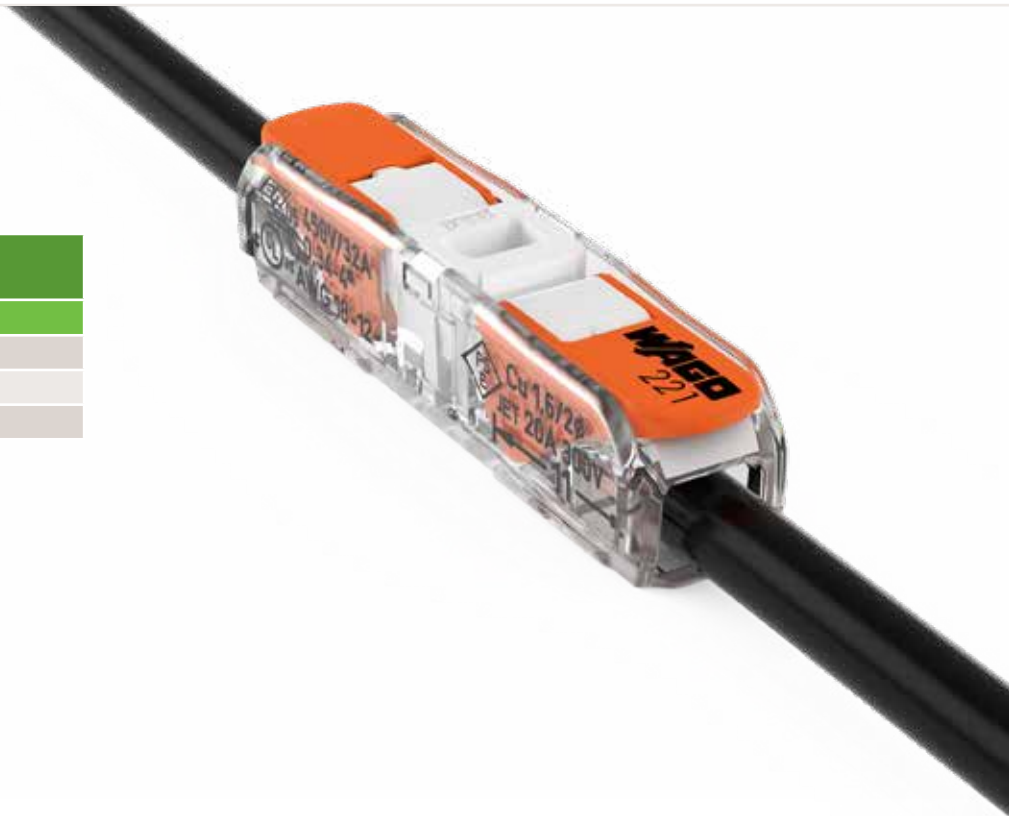

Accessories

Mounting Carrier with Strain Relief				Mounting Carrier without Strain Relief			
For Screw Mount		With Snap-In Foot		For Screw Mount		For Snap-In Foot	
1-way	221-2501	1-way	221-2511	1-way	221-2521	1-way	221-2531
2-way	221-2502	2-way	221-2512	2-way	221-2522	2-way	221-2532
3-way	221-2503	3-way	221-2513	3-way	221-2523	3-way	221-2533
4-way	221-2504	4-way	221-2514	4-way	221-2524	4-way	221-2534
5-way	221-2505	5-way	221-2515	5-way	221-2525	5-way	221-2535
Item Number	Designation	Compatibility		Application		Width	
209-120	Mounting foot	for DIN-35 rail		Snap on carrier with snap-in mounting foot		6.4 mm	
209-123	Mounting foot with screw	for DIN-35 rail		Screw on carrier with mounting flange		6.4 mm	
209-119	Mounting screw	for mounting foot (209-120)					
209-1115	Mounting foot	for DIN-15 rail		Snap on carrier with snap-in mounting foot		6.4 mm	
209-1116	Mounting foot with screw	for DIN-15 rail		Screw on carrier with mounting flange		6.4 mm	

221 SERIES *LEVER-NUTS*®

For Hazardous Locations

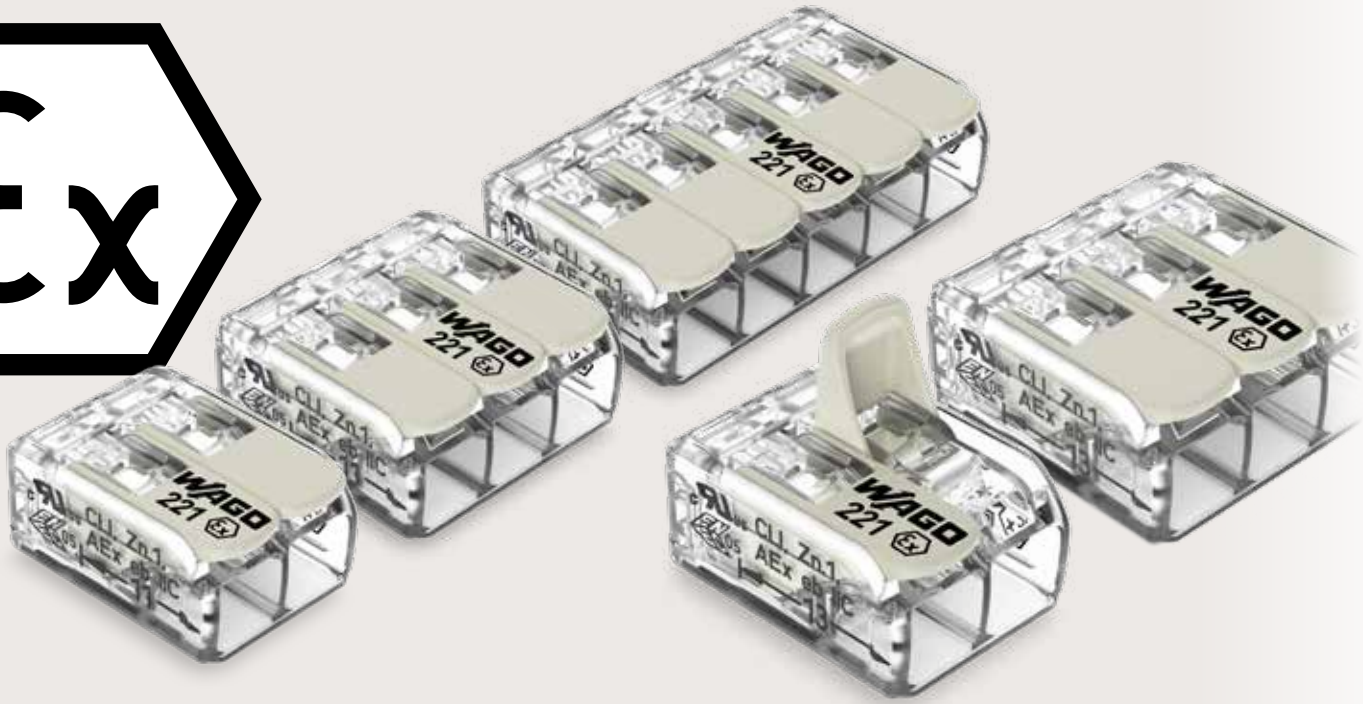

221 SERIES *LEVER-NUTS*®

- Easy, fast and reliable connection technology for products in hazardous areas
- Must be used with mounting carrier to fulfill Ex requirements
- Mounting carrier can be DIN rail mounted or can be screwed down to a smooth surface
- Excellent for junction boxes in haz-loc applications

Electrical Data	12 AWG	10 AWG	
	Rated voltage	440 V with spacing between adjacent connectors 275 V without spacing 600 V for general industry	
Nominal current	20 A	30 A	
Wire Size			
Solid conductor	24 - 12 AWG	20-10 AWG	
Stranded conductor	24 - 12 AWG	20-10 AWG	
Flexible conductor	24 - 12 AWG	20-10 AWG	
Strip length	11 mm / 0.43 in.	13 mm / 0.51 in.	
Maximum operating temperature	105 °C		
Approvals	4 Zone 1, 2	IECEx Class 1, Zone 1	AEx Class 1, Zone 1

221 Series Ex for 12 AWG



L 11 mm / 0.43 in.



L 11 mm / 0.43 in.



L 11 mm / 0.43 in.

2-conductor connector Transparent housing, white levers		3-conductor connector Transparent housing, white levers		5-conductor connector Transparent housing, white levers	
Item No.	Pack.-unit pcs	Item No.	Pack.-unit pcs	Item No.	Pack.-unit pcs
221-482	1=box of 100 pcs	221-483	1=box of 50 pcs	221-485	1=box of 25 pcs

221 Series Ex for 10 AWG



L 11 mm / 0.43 in.

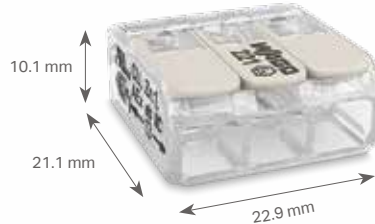

L 11 mm / 0.43 in.



L 11 mm / 0.43 in.

2-conductor connector Transparent housing, white levers		3-conductor connector Transparent housing, white levers		5-conductor connector Transparent housing, white levers	
Item No.	Pack.-unit pcs	Item No.	Pack.-unit pcs	Item No.	Pack.-unit pcs
221-682	1=box of 50 pcs	221-683	1=box of 30 pcs	221-685	1=box of 15 pcs

Easy Operation:



Easily open lever by hand and insert conductor



Easily open lever by hand and insert conductor



Push lever back down



Install connectors into the mounting carrier



Remove connectors - without tools



Secure the carrier using screws on smooth surfaces



Test inserted connectors in the carrier



Rated 440 V with spacing between adjacent connectors



Rated 275 V with no spacing between connectors

222 SERIES *LEVER-NUTS*®

The Original Lever-Operated Splicing Connector

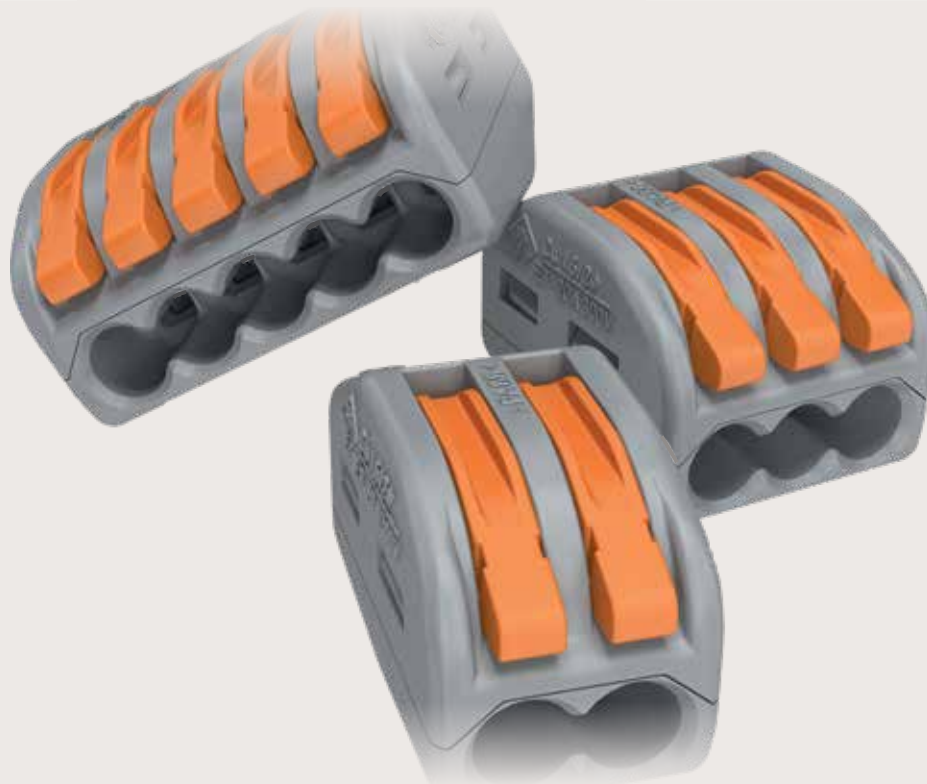

222 SERIES *LEVER-NUTS*®

- For all connections requiring stranded or solid wires
- Wide range of wire sizes
- Combination of different wire sizes and types in one connector
- Built-in test point
- Low installed cost and safe operation
- Maintenance-free connection
- Reusable connector

Electrical Data

Rated voltage	600 V (1000 V signs & fixtures)
Nominal current	20 A

Wire Size

Solid conductor	28 - 12 AWG
Stranded conductor	28 - 12 AWG
Flexible conductor	28 - 12 AWG
Strip length	9 ... 10 mm / 0.37 in.
Maximum operating temperature	105 °C

Approvals



Integrated test port allows for easy testing of connection integrity

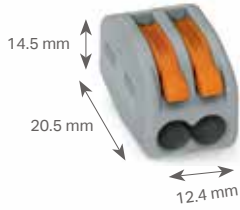

L 9 ... 10 mm / 0.37 in.

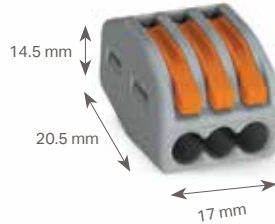

L 9 ... 10 mm / 0.37 in.

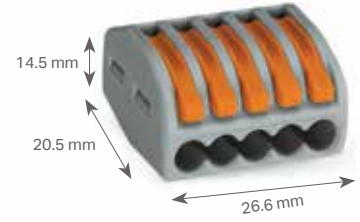

L 9 ... 10 mm / 0.37 in.

2-conductor connector Gray		3-conductor connector Gray		5-conductor connector Gray	
Item No.	Pack.-unit pcs	Item No.	Pack.-unit pcs	Item No.	Pack.-unit pcs
222-412	1=box of 50 pcs	222-413	1=box of 50 pcs	222-415	1=box of 40 pcs
222-412/PW05-0005	1=blister of 5 pcs	222-413/PW05-0005	1=blister of 5 pcs	222-415/PW05-0005	1=blister of 5 pcs
222-412/PW05-350	1=jar of 350 pcs	222-413/PW05-250	1=jar of 250 pcs	222-415/PW05-150	1=jar of 150 pcs
222-412/VE00-2500	2,500 (bulk)	222-413/VE00-2500	2,500 (bulk)	222-415/VE00-1000	1,000 (bulk)

1) Strip wire



2) Pull up lever

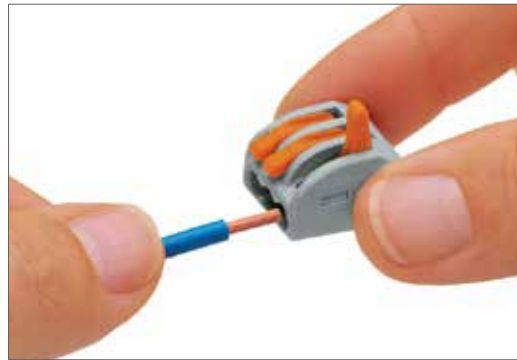

3) Insert conductor and push down lever. Repeat as necessary.



ACCESSORIES

For 221 and 222 Series

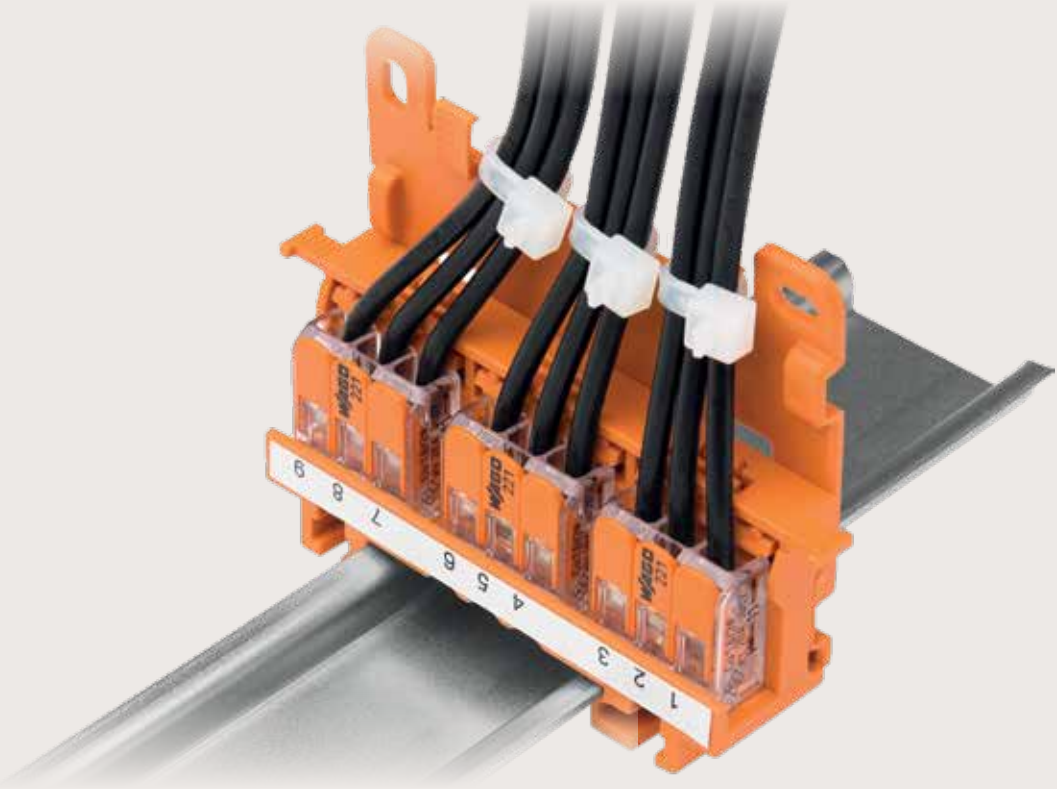

LEVER-NUTS® CAN DO MORE

Mounting accessories convert these connectors into terminal block solutions:

- Mounting flexibility includes horizontal or vertical; snap to DIN rail or screw mount to flat surface
- Multiple cable tie locations
- Marking surfaces available for circuit identification

Assembly:



221: Inserting or removing connector from mounting carrier



222: Inserting or removing connector from the end of the carrier, securing with snap lock



Mounting of strain relief plate to the mounting carrier



Snapping the universal right angled adapter on the mounting carrier



Inserting a conductor into the single mounting carrier



Removing a conductor from the single mounting carrier

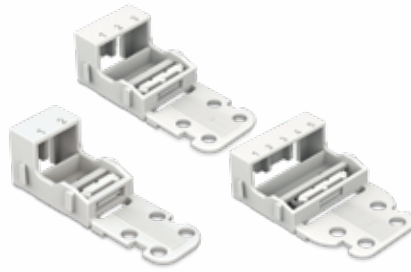

Mounting carriers for 221 Series		Single connector carriers for 221 Series 12 AWG		Operating tools for opening levered splicing connectors	
Item No.	Pack.-unit pcs	Item No.	Pack.-unit pcs	Item No.	Pack.-unit pcs
● 221-500 (12 AWG)	1=box of 10 pcs	○ 221-502 (2-conductor)	1=box of 10 pcs	210-101 (222 Series)	1
● 221-510 (10 AWG)	1=box of 10 pcs	○ 221-503 (3-conductor)	1=box of 10 pcs	210-102 (221 12 AWG)	1
○ 221-501 (Ex)	1=box of 10 pcs	○ 221-505 (5-conductor)	1=box of 10 pcs	210-104 (221 10 AWG)	1
○ 221-S11 (Ex)	1=bag of 10 pcs				



Universal right angled adapter for 221 and 222 Series, combined with mounting carriers for horizontal mounting on DIN rail		Mounting carrier for 222 Series		Strain relief plate for 221 and 222 Series mounting carriers	
Item No.	Pack.-unit pcs	Item No.	Pack.-unit pcs	Item No.	Pack.-unit pcs
● 222-510	10	● 222-500	1=box of 10 pcs	● 222-505	1=box of 10 pcs

Mounting Options:



Vertical mounting on DIN rail with wire ties providing strain relief



Mounting carrier with strain relief plate mounted vertically on flat surface



Vertical mounting with strain relief plate on DIN rail. Wiring locations identified by marker strips



Horizontal mounting with strain relief plate on flat surface. Wiring locations identified using marker strips



Horizontal mounting with strain relief plate on DIN rail using angled DIN rail adapter



Horizontal mounting on DIN rail using angled DIN rail adapter



Horizontal screw mounting with the single carriers



Vertical screw mounting with the single carriers



Connecting a light to the mains





2773 SERIES WALLNUTS®

Compact Splicing Connectors for All Wire Types



2773 SERIES WALLNUTS®

- Connects solid and stranded conductors
- Eliminates wrists and finger strain - no twisting, crimping, or taping required
- Up to 50% faster to terminate wires compared to a twist-type connector
- Compact design - the smallest in the industry, which reduces box fill

Electrical Data	
	12 AWG
Rated voltage	600 V (1000 V signs & fixtures)
Nominal current	20 A
Wire Size	
Solid conductor	20 - 12 AWG
Stranded conductor	16 - 12 AWG
	18 AWG - TC (≤ 9 strands)
Strip length	13 mm / 0.51 in.
Maximum operating temperature	105 °C
Approvals	   

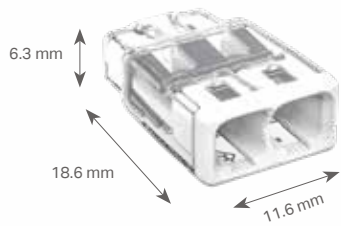

L 11 mm / 0.43 in.

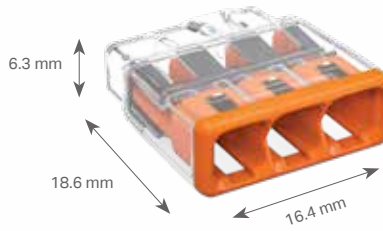

L 11 mm / 0.43 in.

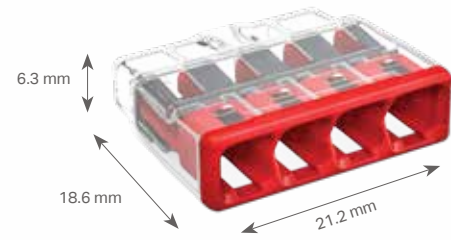

L 11 mm / 0.43 in.

2-conductor connector Transparent housing, white cover		3-conductor connector Transparent housing, orange cover		4-conductor connector Transparent housing, red cover	
Item No.	Pack.-unit pcs	Item No.	Pack.-unit pcs	Item No.	Pack.-unit pcs
2773-402/K000-0002	1=box of 120 pcs	2773-403/K000-0002	1=box of 100 pcs	2773-404/K000-0002	1=box of 80 pcs
2773-402/VE00-2500	2500 (bulk)	2773-403/VE00-2500	2500 (bulk)	2773-404/VE00-2500	2500 (bulk)
2773-402/VE00-0500	500 (bulk)	22773-403/VE00-0500	500 (bulk)	2773-404/VE00-0500	500 (bulk)

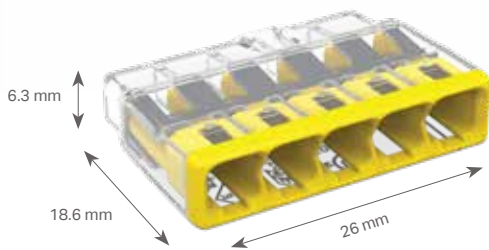

L 11 mm / 0.43 in.

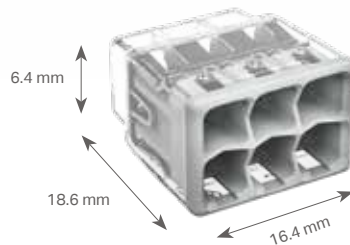

L 11 mm / 0.43 in.

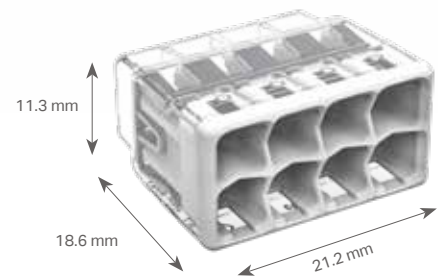

L 11 mm / 0.43 in.

5-conductor connector Transparent housing, yellow cover		6-conductor connector Transparent housing, gray cover		8-conductor connector Transparent housing, light gray cover	
Item No.	Pack.-unit pcs	Item No.	Pack.-unit pcs	Item No.	Pack.-unit pcs
2773-405/K000-0002	1=box of 60 pcs	2773-406/K000-0002	1=box of 50 pcs	2773-408/K000-0002	1=box of 40 pcs
2773-405/VE00-2500	2500 (bulk)	2773-406/VE00-2500	2500 (bulk)	2773-408/VE00-2500	2500 (bulk)
2773-405/VE00-0500	500 (bulk)	2773-406/VE00-0500	500 (bulk)	2773-408/VE00-0500	500 (bulk)

Accessories

Item Number	Designation	Compatibility	Application	Width
2773-500	Mounting carrier	for DIN-35 rail	Screw on mounting carrier	18 mm



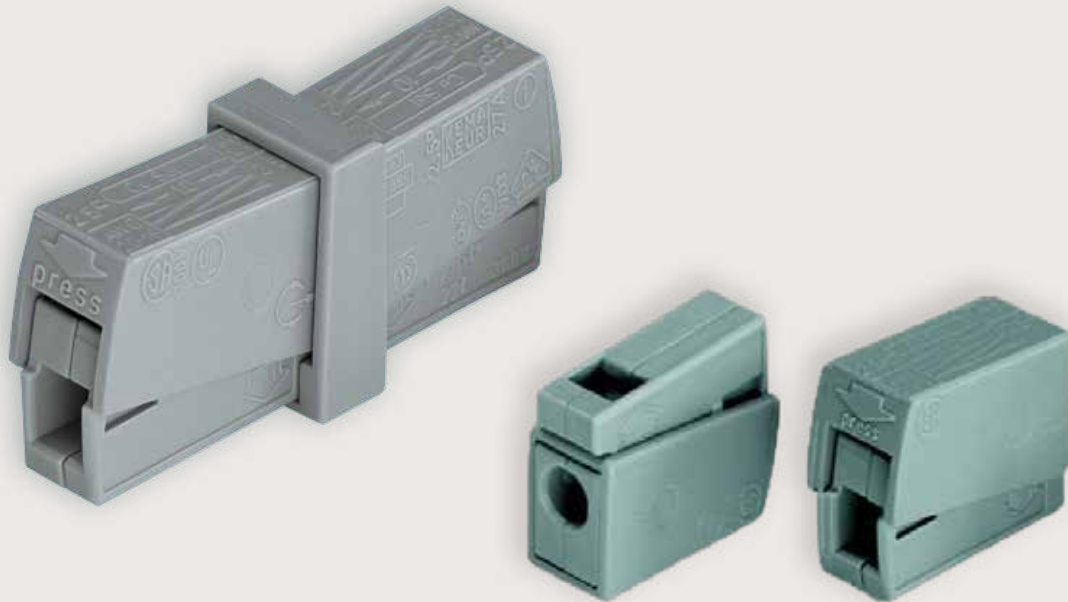

224 SERIES INLINE CONNECTORS

PUSHWIRE® and Squeeze-to-Open



224 SERIES

- Connect solid line-side wire with flexible or stranded load-side wire (eg. ceiling fan or light fixture)
- PUSHWIRE® connect to line side; squeeze to connect load side
- Daisy chain power with 2-conductor line-side versions
- Perfect for use in ceiling fan or fixture installations

Electrical Data		
Rated voltage	300 V	
Nominal current	20 A	
Wire Size	Line Side	Load Side
224-101/224-104	14 - 12 AWG sol	20 - 16 AWG sol / str / flx
224-112/224-114	2x 16 - 14 AWG sol	20 - 16 AWG sol / str / flx
224-201	20 - 16 AWG sol / str / flx (line and load side)	
Strip length	9 ... 11 mm / 0.39 in.	
Maximum operating temp.	105 °C (120 °C)	
Approvals	  VK 	

- The perfect in-line connector for solid-to-flexible wire
- Also with dual squeeze-to-open version for flexible-to-flexible wire
- Tool-free connection

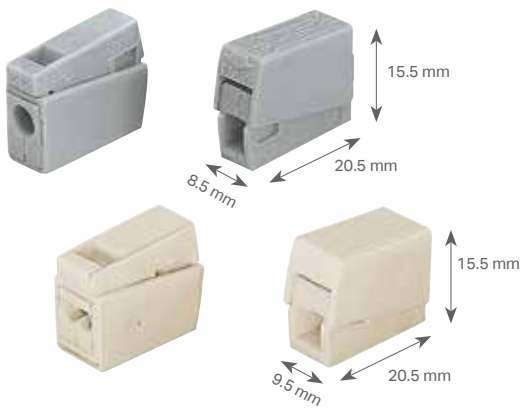

19 ... 11 mm / 0.39 in.

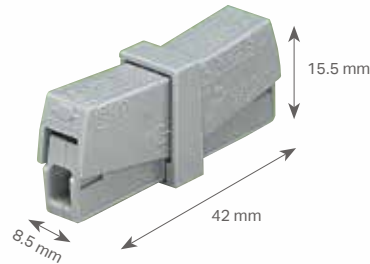

19 ... 11 mm / 0.39 in.



19 ... 11 mm / 0.39 in.

Inline connector with PUSHWIRE® and squeeze-to-open connection

Dual squeeze-to-open connector accepts flexible wire on both sides

Inline connector for increased operating temperature of 120 °C

Item No.	Pack.-unit pcs	Item No.	Pack.-unit pcs	Item No.	Pack.-unit pcs
● 224-101	100	● 224-201	50	● 224-104	100
○ 224-112 (daisy chain)	100			● 224-114 (daisy chain)	100

Line Side



Connection:
Insert stripped solid conductor into circular entry and push to stop

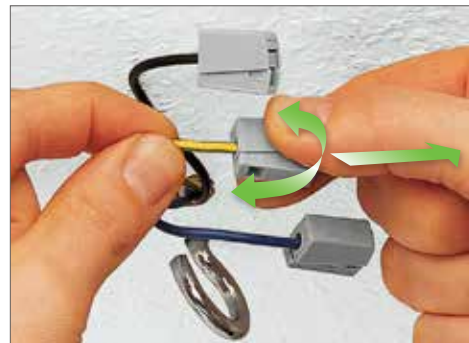

Removal:
Hold wire to be removed and twist and pull the conductor

Load Side



Connection:
Squeeze connector housing and insert stripped conductor into square entry, then release



Removal:
Squeeze connector housing and withdraw conductor



243 SERIES

MICRO PUSHWIRE® Connectors for Junction Boxes



243 SERIES

- Common up to eight small, solid wires quickly and conveniently
- Gang multiple connectors together with their dovetail features
- Test the circuit through the front-facing test port
- Differentiate circuits with multiple color options

Electrical Data	
Rated voltage	150 V
Nominal current	7 A
Wire Size	
Solid conductor	22 - 18 AWG I
Strip length	5 ... 6 mm / 0.22 in.
Maximum operating temperature	105 °C
Approvals	U  

MICRO PUSHWIRE® Connectors for Junction Boxes

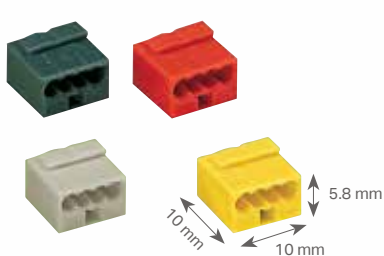

15 ... 6 mm / 0.22 in.

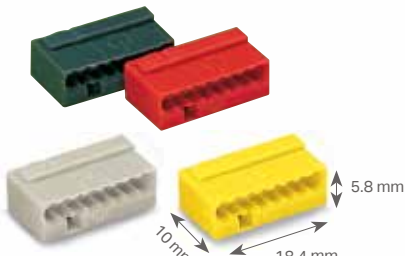

15 ... 6 mm / 0.22 in.

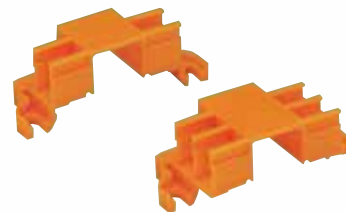

4-conductor connector		8-conductor connector		Mounting carrier for DIN rail or flat surface mounting	
Item No.	Pack.-unit pcs	Item No.	Pack.-unit pcs	Item No.	Pack.-unit pcs
● 243-204	100	● 243-208	50	243-112 (4 connectors)	10
● 243-804	100	● 243-808	50	243-113 (6 connectors)	10
● 243-304	100	● 243-308	50		
● 243-504	100	● 243-508	50		

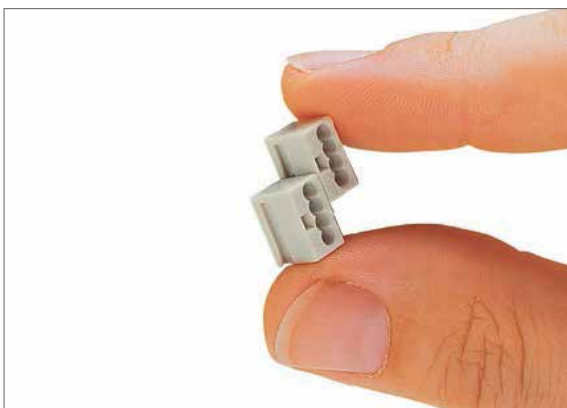

Assemble modular connectors into ganged connector strips

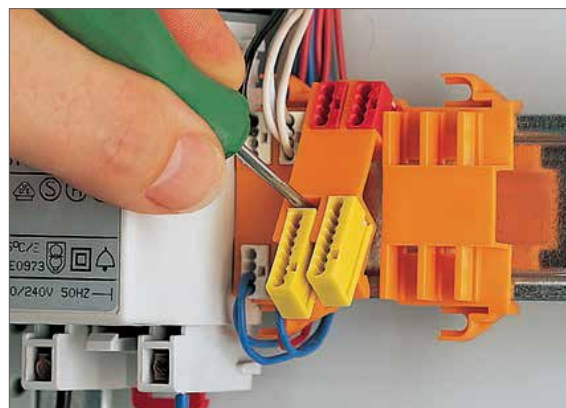

Removing mounting carrier from DIN rail assembly

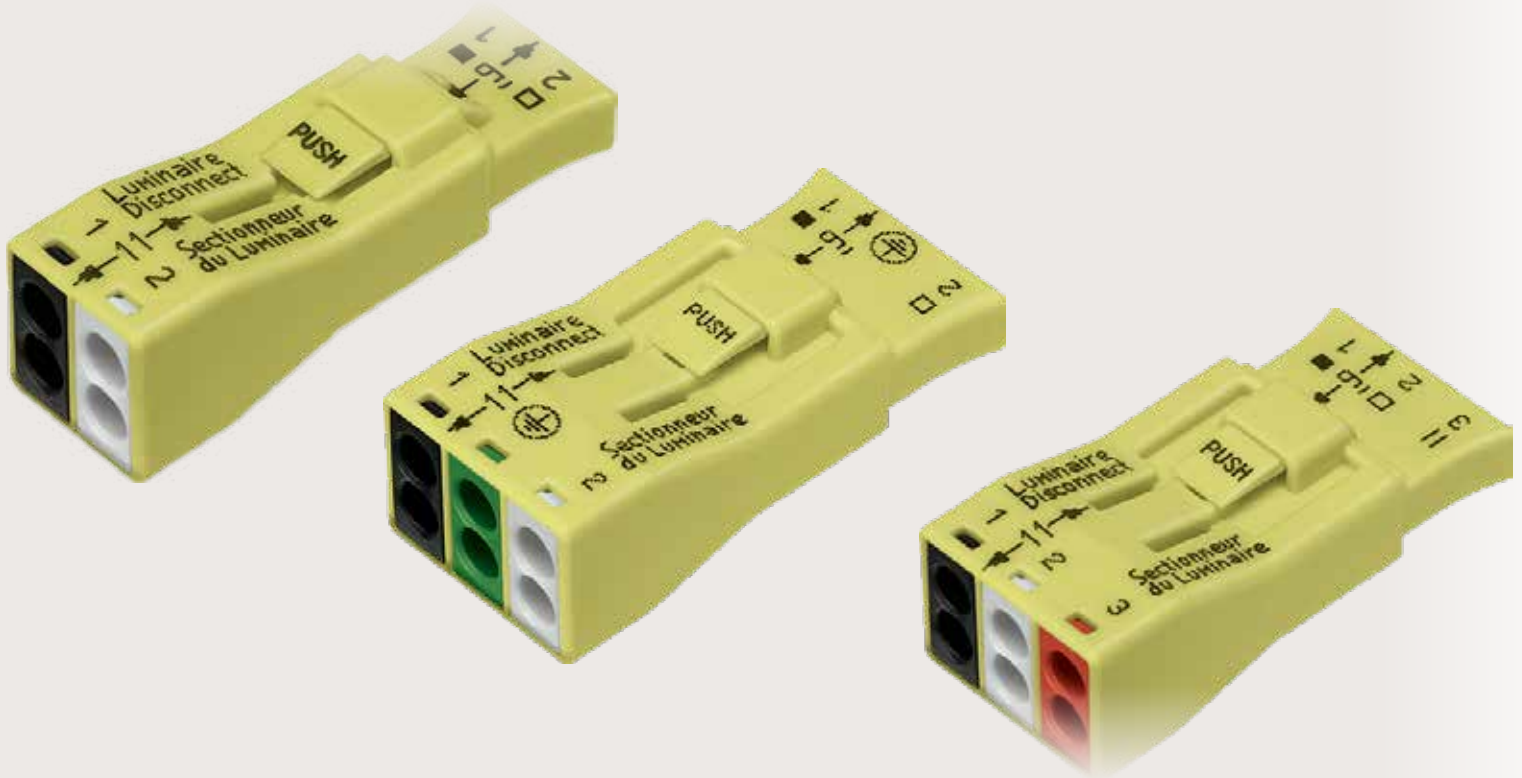

873 SERIES LUMI-NUTS®

PUSHWIRE® Connector for Luminaire Disconnect



873 SERIES LUMI-NUTS®

- Molded in color coding for circuit wiring
- Two connections per pole on male side for daisy chaining
- 20 A current capacity to support multiple fixture loads
- Two-piece contact construction featuring high grade stainless steel spring (for contact force) and electrolytic copper current bar (for electrical integrity)
- Integrated locking latch – automatic locking with mating of connectors – simple push down to disengage
- UL94 V-0 flame retardant rated housing

Electrical Data		
	Male (plug)	Female (socket)
Rated voltage	600 V	600 V
Nominal current	20 A	6 A
Wire Size		
Solid conductor	18 - 12 AWG	18 AWG I
Stranded conductor (≤19 strands)	16 - 12 AWG	
Strip length	11 ... 13 mm / 0.47 in.	9 ... 11 mm / 0.47 in.
Maximum operating temperature		105 °C
Approvals		
 		

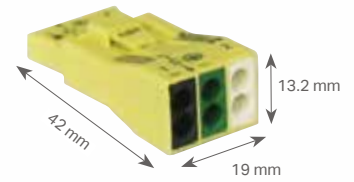
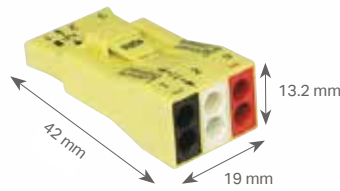
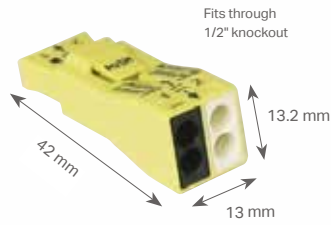

19 ... 11 mm / 0.39 in.

11 ... 13 mm / 0.47 in.

19 ... 11 mm / 0.39 in.

11 ... 13 mm / 0.47 in.

19 ... 11 mm / 0.39 in.

11 ... 13 mm / 0.47 in.

2-pole connector		3-pole connector for switching and dimming applications		3-pole connector with "make first/break last" ground circuit	
Item No.	Pack.-unit pcs	Item No.	Pack.-unit pcs	Item No.	Pack.-unit pcs
873-902	1=box of 25 pcs	873-903	1=box of 20 pcs	873-953/VE00-0500	500 (bulk)
873-902/PW05-200	1=jar of 200 pcs	873-903/PW05-100	1=jar of 100 pcs		
873-902/VE00-0500	500 (bulk)	873-903/VE00-0500	500 (bulk)		
873-902/VE00-5000	2,500 (bulk)				

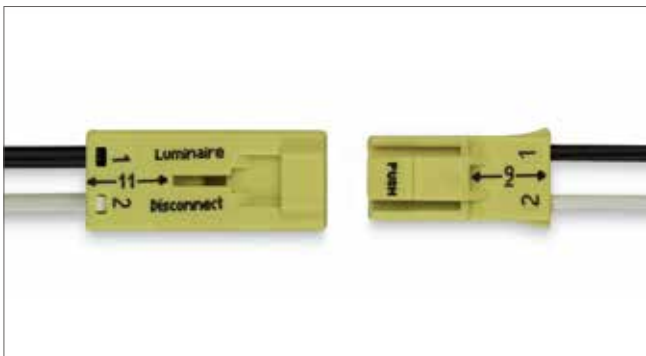

Luminaire disconnect 873-902 (2-pole) in disconnected state. Both plug and socket are touch-proof. Marking details include circuit identification and strip length indication

APPLICATION NOTE

Touch-proof, 'hot-pluggable' connectors are required for ballast supply wiring in the USA and Canada. When exchanging a ballast:

- 1) The touch-proof connector is disconnected first
- 2) The ballast is replaced
- 3) Power connection is restored by plugging the connection back together. This speeds ballast replacement while enhancing safety by protecting the installer from electrical shock.

873 Series LUMI-NUTS® are approved according to UL2459 and CSA 22.2 for this type of application.







862 SERIES

Terminal Blocks for Chassis Mounting



862 SERIES

- Integrated push-button with molded-in slots accommodates fast and easy wiring of all conductor types – by hand or slotted tip/Phillips screwdriver
- Four conductors/pole allows for flexible wiring or convenient jumpering
- Convenient automatic grounding contact available
- Snap-in mounting feet for fast assembly
- Flexible marking options: standard marking (pre-marked), marker strip or custom marked for large quantity orders
- Built-in test points simplify testing with 2 mm / 0.079 in. diameter test plug

Electrical Data			
Rated voltage	300 V	600 V	600 V ¹
Nominal current	20 A	5 A	20 A
Wire Size			
Solid / stranded conductor	22 - 12 AWG U		
Solid / stranded conductor	20 - 12 AWG 2		
Strip length	10 ... 11 mm / 0.41 in.		
Maximum operating temperature	120 °C		
Approvals	 ²     		

¹ 600 V when each wired terminal is surrounded by unused adjacent terminals

² Ex versions available - contact factory for part numbers.

MOUNTING OPTIONS

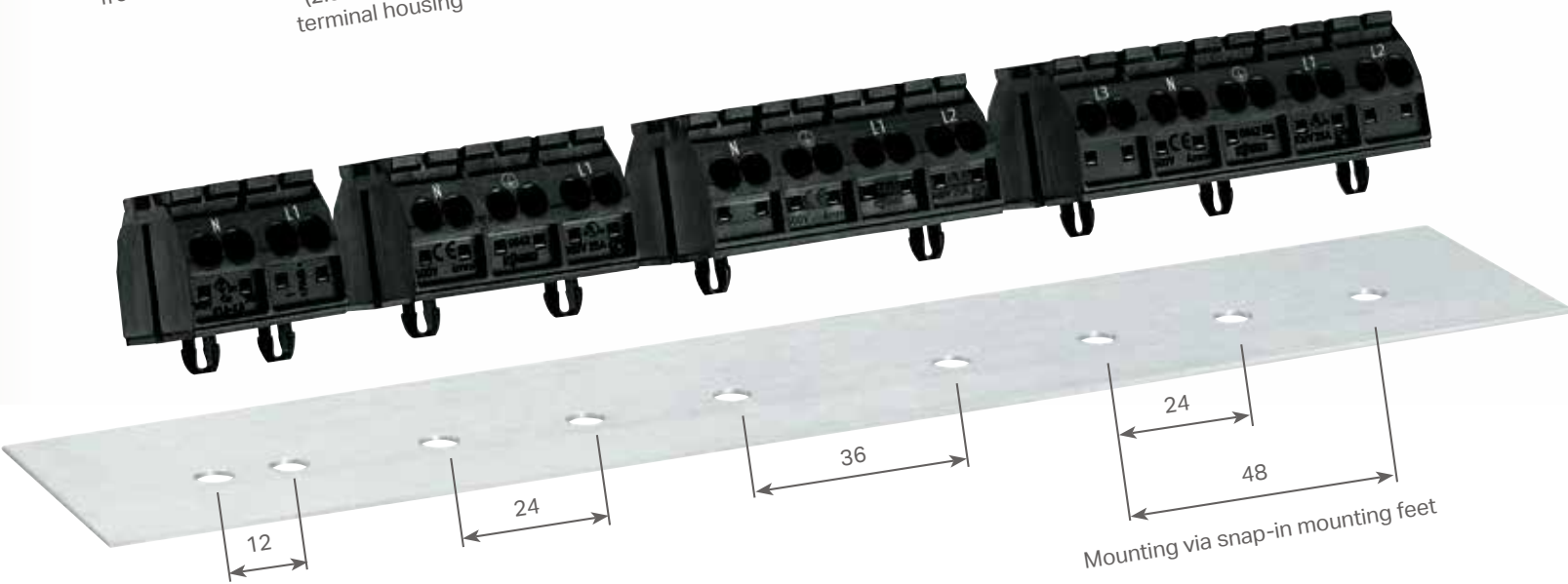
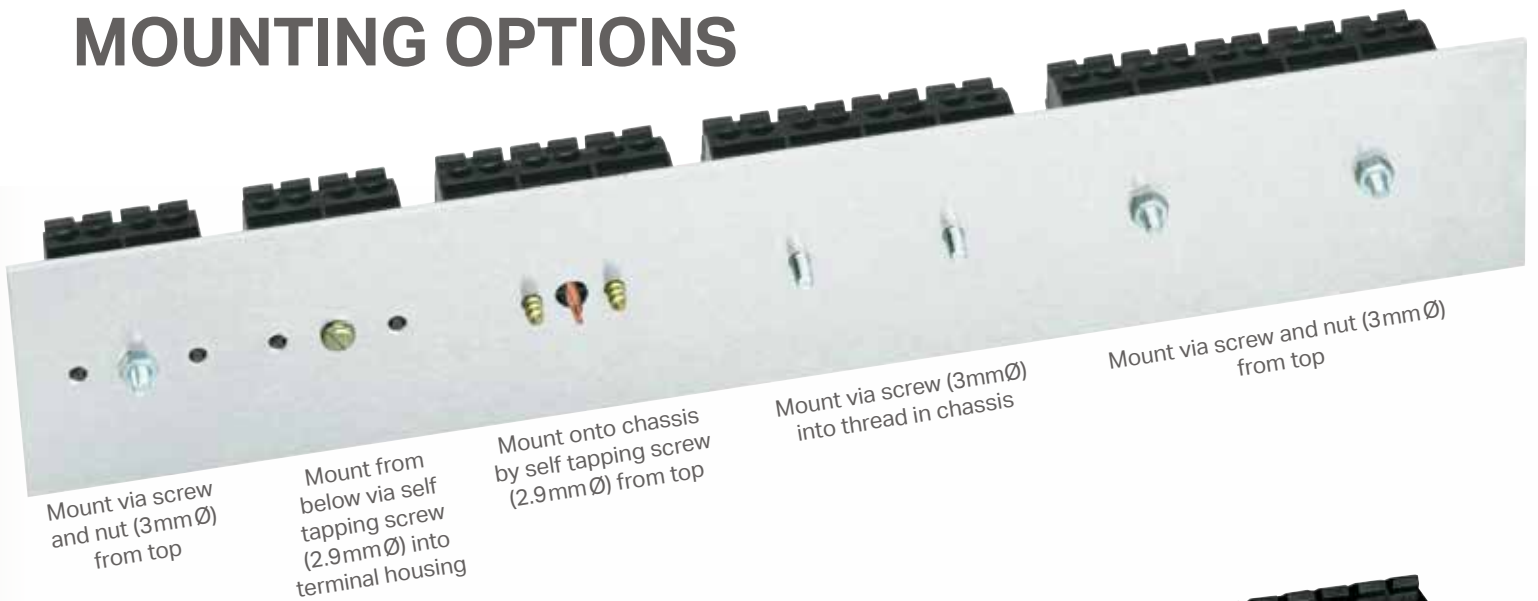

Dimensions (mm)

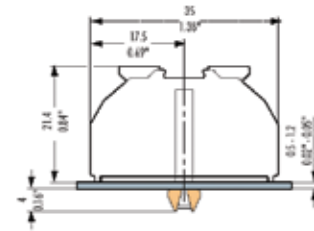
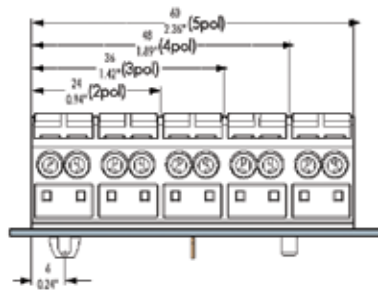
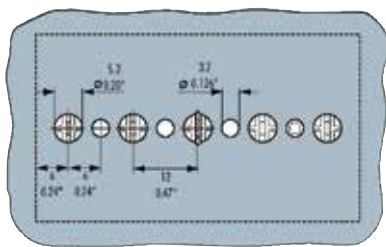

Mounting foot for DIN rail mounting

Item No.	Pack.-unit pcs
209-120	25

862 SERIES TERMINAL BLOCKS

Available in
black and white

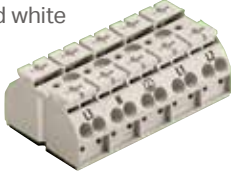

	2 poles/8 connection points			3 poles/12 connection points		
	Item No. black	Item No. white	Pack.-unit pcs	Item No. black	Item No. white	Pack.-unit pcs
for fastening screw (3 mm Ø) or for self tapping screw (2.9) mm Ø from top						
without marking	● 862-552	○ 862-652	500			
L1-N (pre-marked), without ground contact	● 862-1552	○ 862-1652	500			
N-L1 (pre-marked), without ground contact	● 862-2552	○ 862-2652	500			
without marking				● 862-503	○ 862-603	250
PE-N-L1 (pre-marked), without ground contact				● 862-1503	○ 862-1603	250
N-PE-L1 (pre-marked), without ground contact				● 862-2503	○ 862-2603	250
N-PE-L1 (pre-marked), with ground contact				● 862-8503	○ 862-8603	250
PE-N-L1, (pre-marked), with ground contact				● 862-9503	○ 862-9603	250
for self tapping screw 2.9 mm Ø from below						
without marking	● 862-562	○ 862-662	500			
L1-N (pre-marked), without ground contact	● 862-1562	○ 862-1662	500			
N-L1 (pre-marked), without ground contact	● 862-2562	○ 862-2662	500			
1 snap-in foot per pole						
without marking	● 862-532	○ 862-632	500			
L1-N (pre-marked), without ground contact	● 862-1532	○ 862-1632	500			
N-L1 (pre-marked), without ground contact	● 862-2532	○ 862-2632	500			
without marking				● 862-533	○ 862-633	250
PE-N-L1 (pre-marked), without ground contact				● 862-1533	○ 862-1633	250
N-PE-L1 (pre-marked), without ground contact				● 862-2533	○ 862-2633	250
N-PE-L1 (pre-marked), with ground contact				● 862-8533	○ 862-8633	250
PE-N-L1 (pre-marked), with ground contact				● 862-9533	○ 862-9633	250
snap-in feet at pos. 1+3						
without marking				● 862-593	○ 862-693	250
PE-N-L1 (pre-marked), without ground contact				● 862-1593	○ 862-1693	250
N-PE-L1 (pre-marked), without ground contact				● 862-2593	○ 862-2693	250
N-PE-L1 (pre-marked), with ground contact				● 862-8593	○ 862-8693	250
PE-N-L1 (pre-marked), with ground contact				● 862-9593	○ 862-9693	250

Accessories



Test plug, with cable 500 mm		Marker strip, 7.5 mm wide, on roll, 50 m long		Comb-type jumper bar		Screwdriver	
Item No.	Pack.-unit pcs	Item No.	Pack.-unit pcs	Item No.	Pack.-unit pcs	Item No.	Pack.-unit pcs
● 210-136 (2 mm Ø)	1	○ 709-178	1	862-482	5	210-720	1
● 210-137 (2.3 mm Ø)	50 (5 x 10)	○ 709-177	1				



	4 poles/16 connection points			5 poles/20 connection points		
	Item No. black	Item No. white	Pack.-unit pcs	Item No. black	Item No. white	Pack.-unit pcs
for fastening screw (3 mm Ø) or for self tapping screw (2.9) mm Ø from top						
without marking	● 862-504	○ 862-604	200			
PE-N-L1-L2 (pre-marked), without ground contact	● 862-1504	○ 862-1604	200			
N-PE-L1-L2 (pre-marked), without ground contact	● 862-2504	○ 862-2604	200			
N-PE-L1-L2 (pre-marked), with ground contact	● 862-8504	○ 862-8604	200			
PE-N-L1-L2 (pre-marked), with ground contact	● 862-9504	○ 862-9604	200			
without marking				● 862-505	○ 862-605	200
PE-N-L1-L2-L3 (pre-marked), without ground contact				● 862-1505	○ 862-1605	200
L3-N-PE-L1-L2 (pre-marked), without ground contact				● 862-2505	○ 862-2605	200
L3-N-PE-L1-L2 (pre-marked), with ground contact				● 862-8505	○ 862-8605	200
PE-N-L1-L2-L3 (pre-marked), with ground contact				● 862-9505	○ 862-9605	200
1 snap-in foot per pole						
without marking	● 862-534	○ 862-634	200			
PE-N-L1-L2 (pre-marked), without ground contact	● 862-1534	○ 862-1634	200			
N-PE-L1-L2 (pre-marked), without ground contact	● 862-2534	○ 862-2634	200			
N-PE-L1-L2 (pre-marked), with ground contact	● 862-8534	○ 862-8634	200			
PE-N-L1-L2 (pre-marked), with ground contact	● 862-9534	○ 862-9634	200			
snap-in feet at pos. 1 + 4						
without marking	● 862-594	○ 862-694	200			
PE-N-L1-L2 (pre-marked), without ground contact	● 862-1594	○ 862-1694	200			
N-PE-L1-L2 (pre-marked), without ground contact	● 862-2594	○ 862-2694	200			
N-PE-L1-L2 (pre-marked), with ground contact	● 862-8594	○ 862-8694	200			
PE-N-L1-L2 (pre-marked), with ground contact	● 862-9594	○ 862-9694	200			
snap-in feet at pos. 2 + 4						
without marking				● 862-525	○ 862-625	200
PE-N-L1-L2-L3 (pre-marked), without ground contact				● 862-1525	○ 862-1625	200
L3-N-PE-L1-L2 (pre-marked), without ground contact				● 862-2525	○ 862-2625	200
L3-N-PE-L1-L2 (pre-marked), with ground contact				● 862-8525	○ 862-8625	200
PE-N-L1-L2-L3 (pre-marked), with ground contact				● 862-9525	○ 862-9625	200
snap-in feet at pos. 1 + 3 + 5						
without marking				● 862-515	○ 862-615	200
PE-N-L1-L2-L3 (pre-marked), without ground contact				● 862-1515	○ 862-1615	200
L3-N-PE-L1-L2 (pre-marked), without ground contact				● 862-2515	○ 862-2615	200
L3-N-PE-L1-L2 (pre-marked), with ground contact				● 862-8515	○ 862-8615	200
PE-N-L1-L2-L3 (pre-marked), with ground contact				● 862-9515	○ 862-9615	200

Versions available with ATEX and IECEx — contact factory for part numbers.

ACCESSORIES & OPERATING TOOLS

Convenient and Fast

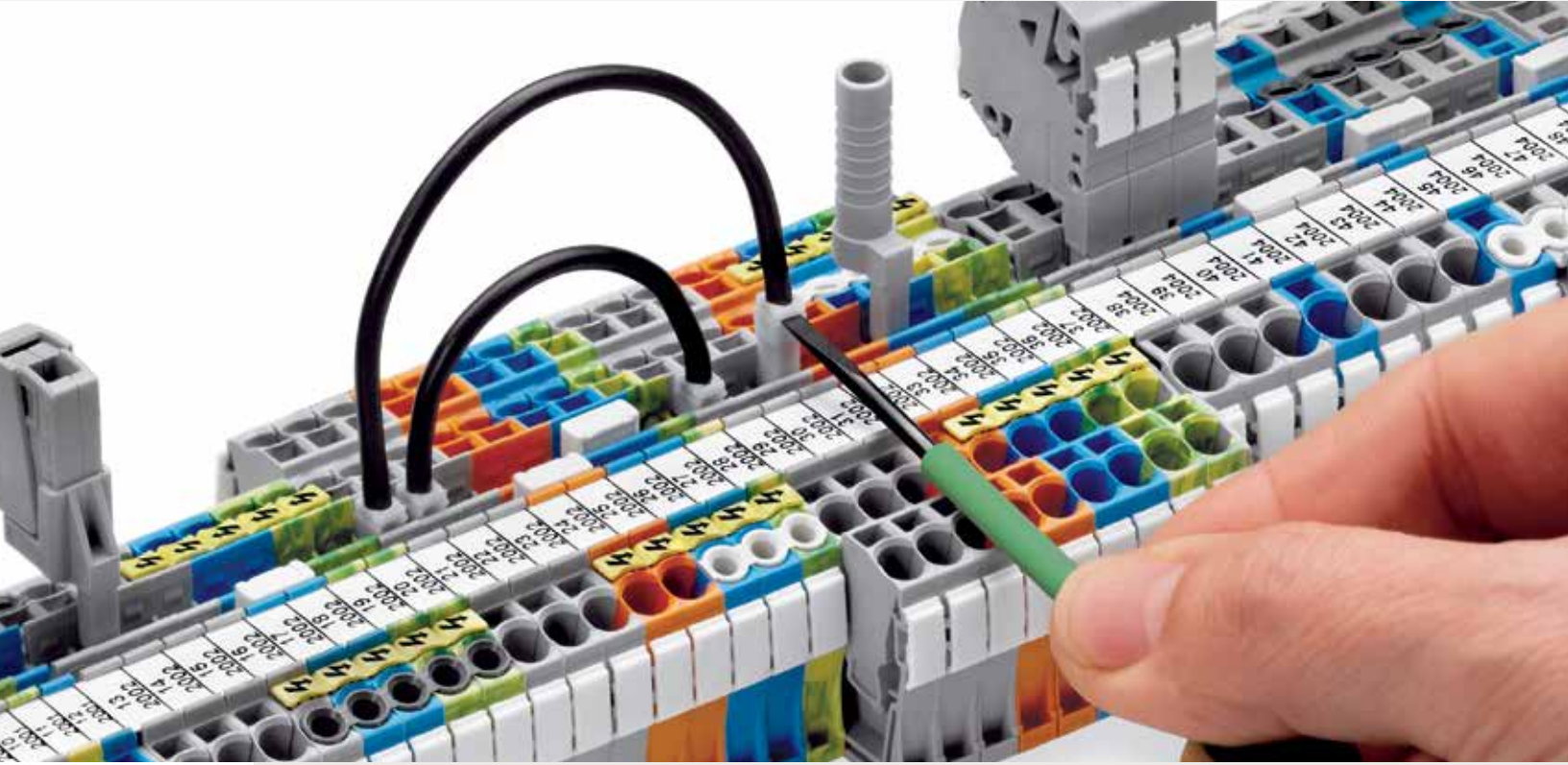

ACCESSORIES

WAGO offers a complete range of accessory products to make installation and testing quick and easy:

- Operating tools for actuating the CAGE CLAMP®
- Test devices and accessories to reliably detect voltage
- Convenient wire cutting and stripping tools
- Ferrules and crimping tools to install them

Stripping and Cutting Tools

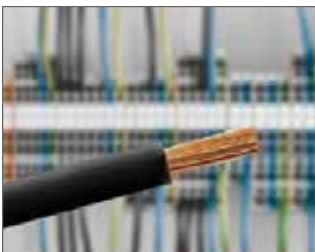

Ferrules



Crimping Tools



Test and Measurement Devices



Screwdrivers and Banana Plugs

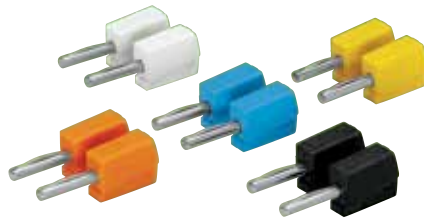

Screwdriver		Banana plugs, for sockets Ø 4 mm 28 - 14 AWG	
Item No.	Pack.-unit pcs	Item No.	Pack.-unit pcs
210-719 (2.5 x 0.4 mm blade)	1	215-111 (mixed colors)	50
210-720 (3.5 x 0.5 mm blade)	1	● 215-211	50
210-721 (5.5 x 0.8 mm blade)	1	● 215-212	50
210-722 (set of all 3)	1	● 215-311	50
		● 215-411	50
		● 215-511	50
		● 215-711	50
		● 215-811	50
		● 215-911	50



Set of screwdrivers in a box

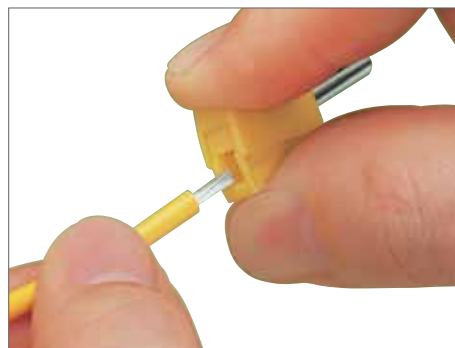

Connection of conductors via banana plugs:
Press button fully and insert stripped
conductor into square entry and release

Wire Stripping and Cutting Tools



Quickstrip vario wire stripper with integrated wire cutter 32 - 6 AWG		Replacement blade cassettes for Quickstrip tool		Stripping pliers for sensor wires Ø .13"17"	
Item No.	Pack.-unit pcs	Item No.	Pack.-unit pcs	Item No.	Pack.-unit pcs
206-1125	1	206-1126 (Standard blade for Quickstrip)	1	206-1481	1
		206-1127 (V blade/PTFE wire for Quickstrip)	1		
		206-1128 (Blade set for Quickstrip, oval blade)	1		



Stripping pliers for control wires Ø .17"28"		Tool kit Includes Quickstrip 10 and Variocrimp 4	
Item No.	Pack.-unit pcs	Item No.	Pack.-unit pcs
206-1482	1	60348435	1



Automatic stripping for control and sensor wires



Convenient, stackable kit design



Capable of partial strip and features integrated wire cutter

Cable Stripping and Cutting Tools



Cable cutter for up to 2 AWG conductors		Cable knife with intelligent bracket change system Ø .31" ... 1.10"		Cable knife kit includes all cable brackets in an L-boxx mini Ø .16" ... 2.75"	
Item No.	Pack.-unit pcs	Item No.	Pack.-unit pcs	Item No.	Pack.-unit pcs
206-118	1	206-1403	1	206-1400	1



Cable stripper; in-socket Ø .31"51"		Cable stripper; universal Ø .31"51" From 8 mm ... 13 mm		Cable stripper; data Ø .18"40" From 4.5 mm ... 10 mm	
Item No.	Pack.-unit pcs	Item No.	Pack.-unit pcs	Item No.	Pack.-unit pcs
206-1441	1	206-1442	1	206-1451	1



Cutting of cable



Spiral cut cable stripper



Intelligent bracket change system

Ferrules and Crimping Tools

Insulated Ferrules

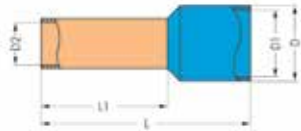

Uninsulated Ferrules

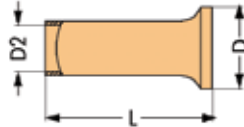

Insulated Ferrules

Sleeve for mm ²	AWG	Stripped length (mm)	L (mm)	L1 (mm)	D (mm)	D1 (mm)	D2 (mm)	Item No.	Pack.-unit pcs
0.5	20	12.0	16.0	10.0	3.1	2.6	1.0	○ 216-241	1,000
0.75	18	12.0	16.0	10.0	3.3	2.8	1.2	● 216-242	1,000
1.0	18	12.0	16.0	10.0	3.5	3.0	1.4	● 216-243	1,000
1.5	16	12.0	16.0	10.0	4.0	3.5	1.7	● 216-244	1,000

Uninsulated Ferrules

Sleeve for mm ²	AWG	Stripped length (mm)	L (mm)	D (mm)	D2 (mm)	Item No.	Pack.-unit pcs
0.5	20	10.0	10.0	2.1	1.0	216-141	1,000
0.75	18	10.0	10.0	2.3	1.2	216-142	1,000
1.0	18	10.0	10.0	2.5	1.4	216-143	1,000
1.5	16	10.0	10.0	2.8	1.7	216-144	1,000

Crimping Tools



Variocrimp 4 For insulated and uninsulated ferrules, 24 - 12 AWG		Variocrimp 16 For insulated and uninsulated ferrules, 10 - 6 AWG		Ferrule kit Includes 1000 pcs of 20 AWG (216-241), 1000 pcs of 18 AWG (216-242), 1000 pcs of 18 AWG (216-243), 500 pcs of 16 AWG (216- 264), 500 pcs of 14 AWG (216-266), and 400 pcs of 12 AWG (216-267)	
Item No.	Pack.-unit pcs	Item No.	Pack.-unit pcs	Item No.	Pack.-unit pcs
206-1204	1	206-1216	1	60348433	1

Test and Measurement Devices

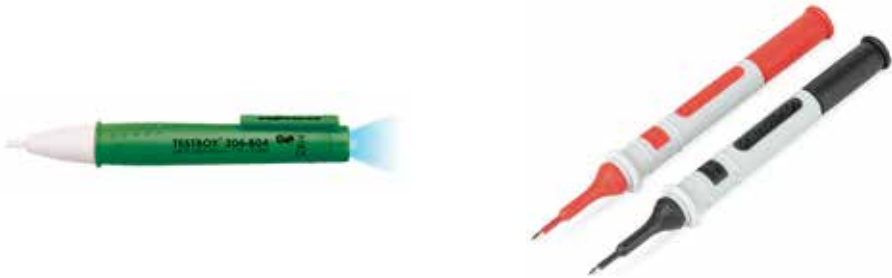

Testboy with integrated flashlight		Test Probes	
Item No.	Pack.-unit pcs	Item No.	Pack.-unit pcs
206-804	1	206-912	1
<ul style="list-style-type: none"> Voltage range: 12 - 1000 VAC 		<ul style="list-style-type: none"> 2 mm Ø; 1000 V; CAT IV; 10 A 	



Testboy illuminates with voltage present

WAGO Corporation
N120 W19129 Freistadt Road
Germantown, Wisconsin 53022
Telephone: 800 / DIN-Rail (346-7245)
Fax: 262 / 255-3232
info.us@wago.com
www.wago.us

WAGO Canada Inc.
1550 Yorkton Court, Unit 1
Burlington, ON
L7P 5B7
Telephone: 888 / WAGO 221 (924-6221)
info.ca@wago.com
www.wago.ca

WAGO SA DE CV
Carretera estatal 431 Km. 2+200. Lote 99 6
Parque Industrial Tecnológico Innovación Querétaro
El Marques, Qro. 76246
Lada sin Costo: 01 800 288 WAGO (288-9246)
Telefono: 422 / 221-5946
info.mx@wago.com
www.wago.mx

WAGO is a registered trademark of WAGO Verwaltungsgesellschaft mbH.

"Copyright – WAGO Kontakttechnik GmbH & Co. KG – all rights reserved. The content and structure of the WAGO Websites, catalogs, videos, and other WAGO media are subject to copyright. The dissemination or changing of the content of these pages and videos is not permitted. Furthermore, the content may neither be copied nor made available to third parties for commercial purposes. Also subject to copyright are the images and videos that were made available to WAGO Kontakttechnik GmbH & Co. KG by third parties."