

HYDH

HYGIENIC DOOR HANDLE



**THE
HYGIENIC DOOR HANDLE**

OPTIMIZE YOUR HYGIENE CONCEPT

...GIVE PATHOGENS NO CHANCE

Everybody operates door handles. Consequently, one can assume a particularly strong germ infestation here. - Especially at places with a lot of public traffic, there is an increased risk. With HYDH you reduce the transmission possibilities of e.g., corona and influenza viruses and bacteria easily and effectively in all areas.



Time-saving mounting

Quick and straightforward installation is guaranteed due to the tool-free mounting of the HYDH on the door handle.



Hygienic Design

The robust material constitution of the HYDH is resistant to cleaning agents and disinfectants.



Flexibility

You can mount HYDH on the door (left and right hinged) as required. It is suitable for a wide range of different door handles. (See the illustration on page 3.)



Manipulation protection

Toolless mounting of the supplied tamper-proof clamps protects the HYDH against tampering and theft.

MOUNTING DETAILS

HYDH is suitable for mounting on round and oval door handles as well as square handles (dimensions see page 5). Without tools (left/right hinged), it is simply and securely snapped onto the existing door handle.

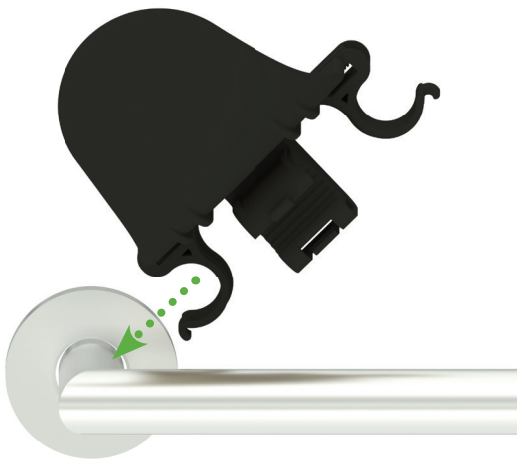

STEP 1

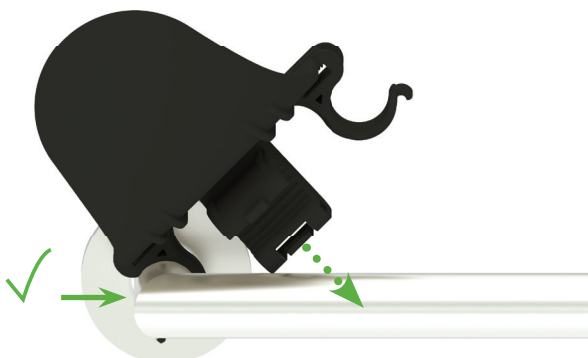

STEP 2

INTERMEDIARY RESULT

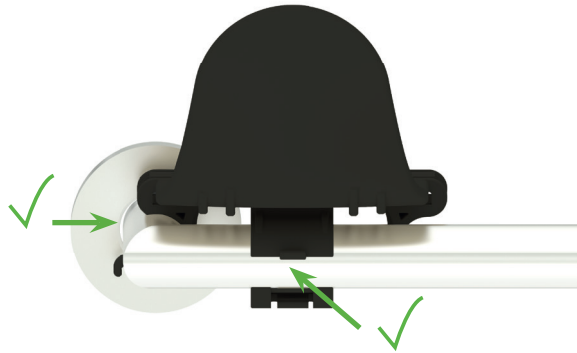

STEP 3

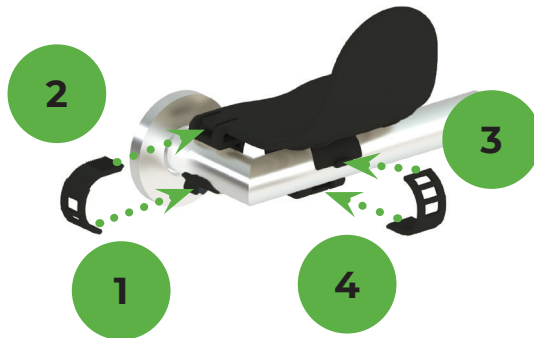

MOUNTING COMPLETED

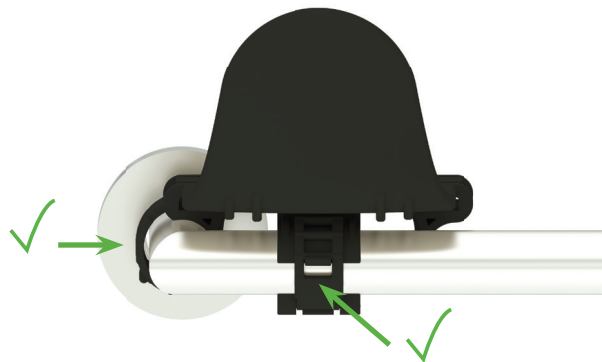

The HYDH is not permitted for doors according to EN 179:2008 (escape routes) and doors according to DIN 18 273:1997 (special fire protection)

DIMENSIONS AND STRUCTURE

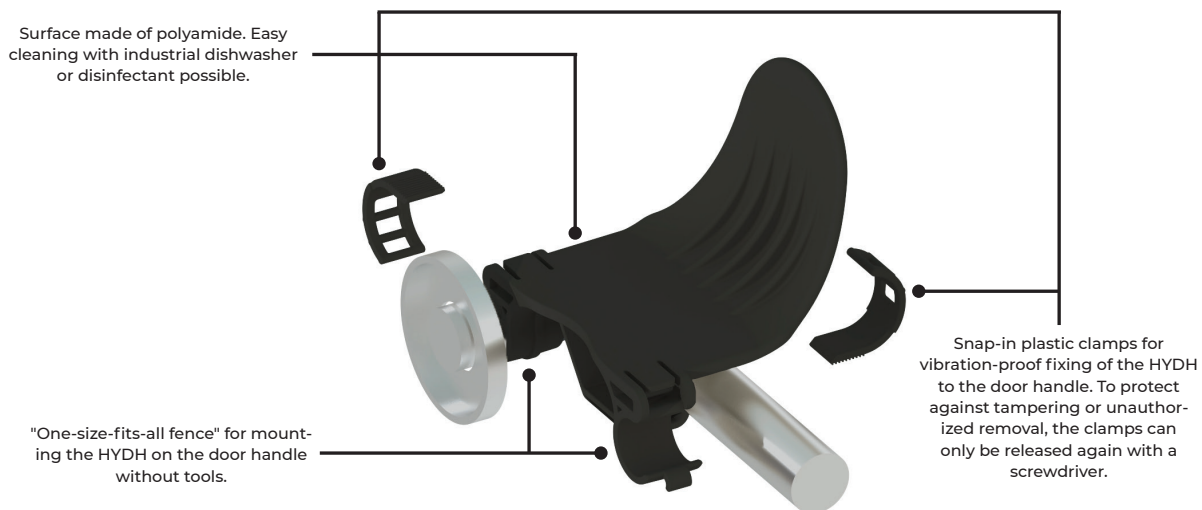

DIAMETER LATCH SIZE "ROUND":

Ø Min.: 19 mm
Ø Max.: 22,5 mm



DIMENSION LATCH SIZE "SQUARE":

Ø Min.: 9 mm x 21 mm
Ø Max.: 16 mm x 16 mm

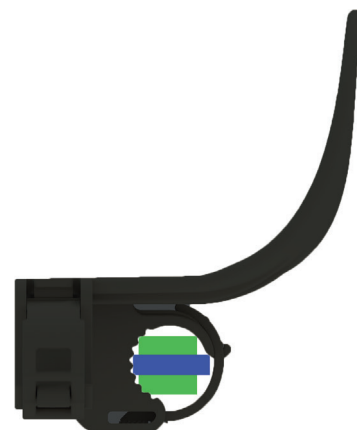

ORDER HYDH NOW!

...GIVE PATHOGENS NO CHANCE

Now equip your doors with our HYDH. Slow down actively the spread of bacteria, viruses, fungi, and other pathogens. The realisation of individual colour preferences and font inserts with unique logos is possible on request.

Dimensions: (HxWxD) 90x109x115 mm	Weight: 77 g	Packing unit: 1
--	----------------------------	-------------------------------

Colours:



Article numbers:

1HYDH.1 1HYDH.2 1HYDH.3 1HYDH.4 1HYDH.5 1HYDH.6 1HYDH.7 1HYDH.8 1HYDH.9