

swissbit®

Product Data Sheet

Industrial
USB Flash Drive Module

U-110 Series
USB2.0 high speed

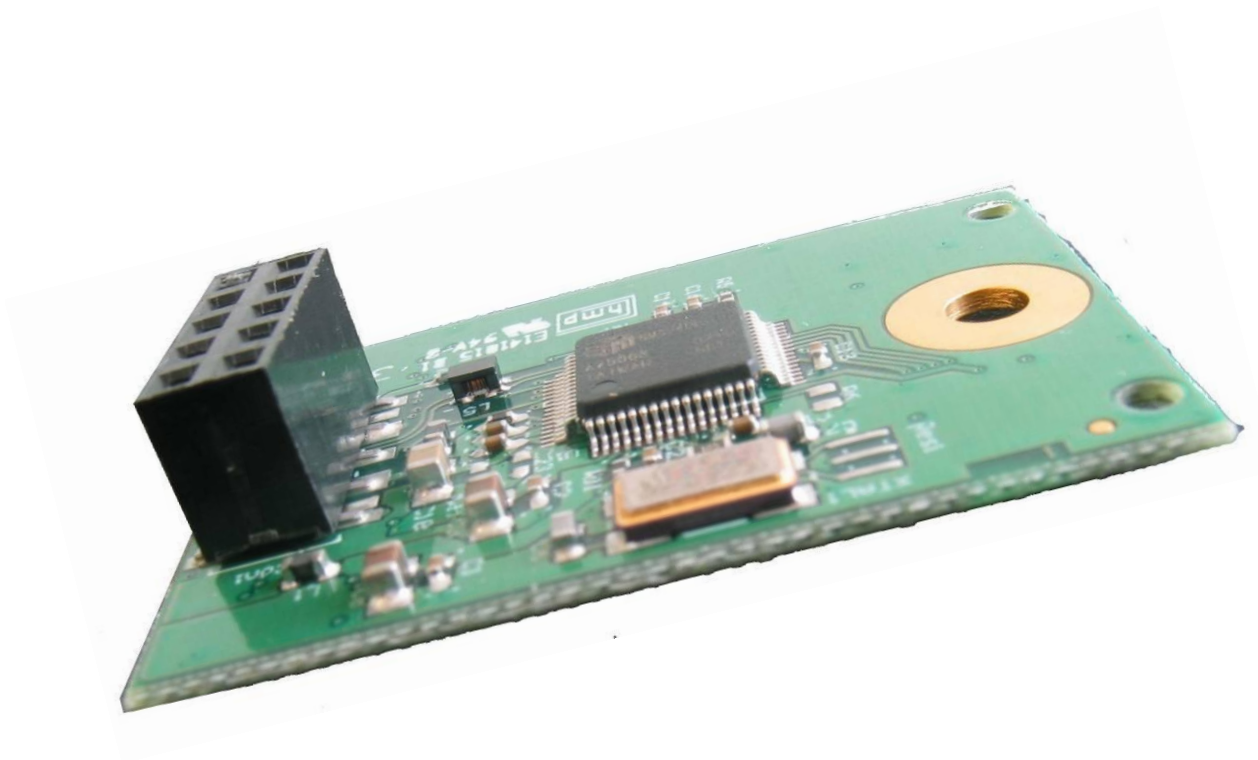

U-110 Series USB Flash Drive Module

1GByte to 16GByte

USB Flash Drive Module provides non-volatile, solid-state storage in a compact design, making it perfectly suited for embedded applications. The standard USB 2.0 interface provides designers with a true plug-n-play storage device, allowing for short design cycles and fast time to market.

Swissbit use high end USB 2.0 flash memory controller in the Module, providing high data reliability and endurance. The built-in BCH-ECC engine can detect up to 9-bit errors and correct up to 8-bit errors, while sophisticated wear leveling algorithms guarantee up to 2,000,000 Write Cycles.

The internal USB Flash Drive Module has an internal 9(10) pin USB connector.

High performance, high reliability and low cost per megabyte make the internal USB Flash Drive Module the product of choice in embedded applications, such as Gaming, POS Workstations, Networking Equipment and Industrial PCs.

Swissbit offers value-added services to OEM customers, such as controlled Bill of Materials, customized preloads, custom setting, customer-specific marking etc.

1 Feature summary

- USB2.0 solid state flash Drive for internal 9(10)-pin USB connector
 - Fully compliant with USB-Specification 2.0 (High-Speed, 480Mb/s burst)
 - Fully backward compliant with USB 1.1 systems (Full speed, 12Mb/s burst)
- High reliability
 - Error correction code (ECC)
 - Wear leveling
 - MTBF >3,000,000 hours
 - Data reliability: < 1 non-recoverable error per 10¹⁴ bits read
- Commercial and industrial temperature grade
- Plug & Play
- Bootable
- Fixed drive
- LED indicator
- FAT32 format
- Unique serial number
- USB-IF high speed certified
- CE / FCC
- RoHS compliant
- WEEE

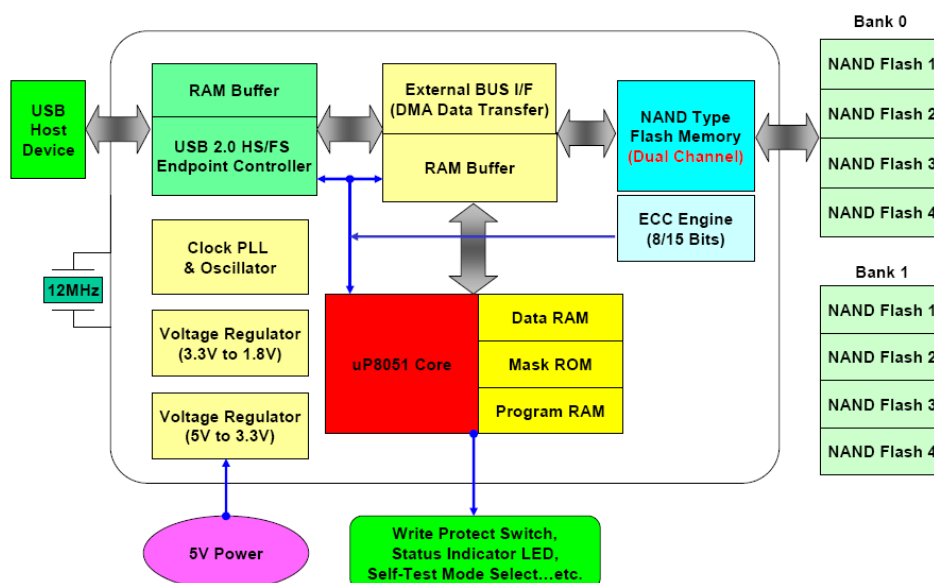

2 Table of Content

1 FEATURE SUMMARY	2
2 TABLE OF CONTENT	3
3 ORDER INFORMATION	4
3.1 STANDARD PRODUCT WITH 2.54MM CONNECTOR	4
3.2 LOW PROFILE PRODUCT WITH 2.00MM CONNECTOR	4
3.3 OFFERED OPTIONS FOR CUSTOM PRODUCTS	4
4 SYSTEM PERFORMANCE.....	5
5 INTERFACE.....	5
6 NAND FLASH TECHNOLOGIES	5
7 ELECTRICAL SPECIFICATION	6
8 ENVIRONMENTAL SPECIFICATION AND RELIABILITY.....	7
8.1 RECOMMENDED OPERATING CONDITIONS.....	7
8.2 RELIABILITY	7
8.3 SHOCK, VIBRATION, AND HUMIDITY	7
9 COMPATIBILITY & COMPLIANCE	7
10 APPLICATIONS.....	8
11 PERFORMANCE REFERENCE	8
11.1 TEST EQUIPMENT.....	8
11.2 PERFORMANCE RESULTS	8
12 STANDARD FORM FACTORS AND HARDWARE.....	9
13 ROHS AND WEEE UPDATE FROM SWISSBIT.....	12
14 BEST PRACTICES	14
14.1 WEAR LEVELING AND SPARE BLOCK MANAGEMENT.....	14
14.1 DEVICE REMOVAL & POWER FAILURE	14
14.2 LIFETIME END HANDLING.....	14
15 PART NUMBER DECODER.....	15
16 LABEL.....	17
17 ROHS AND WEEE UPDATE FROM SWISSBIT.....	18
18 REVISION HISTORY.....	20

3 Order Information

3.1 Standard product with 2.54mm connector

Capacity	Part Number
1GB	SFUI1024JgBP2xx-t-xx-2f1-STD
2GB	SFUI2048JgBP2xx-t-xx-2f1-STD
4GB	SFUI4096JgBP2xx-t-xx-2f1-STD
8GB	SFUI8192JgBP2xx-t-xx-2f1-STD
16GB	SFUI16GBJgBP2xx-t-xx-2f1-STD

Table 1: Product List - 2.54mm

g = hardware generation

t = temperature grade (C=0°C to 70°C and I=-40°C to +85°C)

f = firmware generation per product type

3.2 Low profile product with 2.00mm connector

Capacity	Part Number
1GB	SFUI1024KgBP2xx-t-xx-2f1-STD
2GB	SFUI2048KgBP2xx-t-xx-2f1-STD
4GB	SFUI4096KgBP2xx-t-xx-2f1-STD
8GB	SFUI8192KgBP2xx-t-xx-2f1-STD
16GB	SFUI16GBKgBP2xx-t-xx-2f1-STD

Table 2: Product List -2.00mm

g = hardware generation

t = temperature grade (C=0°C to 70°C and I=-40°C to +85°C)

f = firmware generation per product type

3.3 Offered options for custom products

- Removable or fixed drive
- Customer specified strings and IDs
- FAT16, FAT32 format or customer file system, default FAT32
- Preload service
- CD partition
- Auto run option
- Dongle functionality
- Extended and Industrial Temperature range

Please ask our sales for more details and additional features.

4 System performance

Speed	High Speed mode (max)	Full Speed mode (max)	unit
Burst	480	12	Mbit/s
Read	32 ¹⁾	1.0	MByte/s
Write	23 ¹⁾	0.9	

¹⁾ Effective speed varies with controller, number and type of flash, host, file size, file system and operating system
The USB drive can be busy for max. 320ms from time to time due to internal reorganization.

5 Interface

- USB-connector 10pin (2mm or 2.54mm pitch)
- USB 2.0 high speed interface, USB1.1 full speed compatible

Pin	Signal	Comment
1	V_Bus	Operating voltage
2	NC	Not Connected
3	D-	Data signal pair
4	NC	Not Connected
5	D+	Data signal pair
6	NC	Not Connected
7	GND	Ground
8	NC	Not Connected
9	NC	Keyed at the 2.54mm connector Keyed at the 2.00mm connector (optional not keyed)
10	Shield	should be connected with host shield, is connected with card ground for standard products, could be configured as NC on request

6 NAND Flash technologies

SLC and MLC flash

- Single-level-cell (SLC) flash, 1 bit (1 level) is stored in each memory cell
- Multi-level-cell (MLC) flash, 2 bit (3 level) are stored in each memory cell

Differences

	SLC	MLC ¹⁾	comment
Endurance	~100,000	~5,000	physical write/erase cycles
Write Performance	fast write	slow write	MLC write is more time consuming because of 4 states
Read Performance	fast read	fast read	MLC and SLC technology is similar in the read performance
Reliability	high	normal	errors are more likely, because the 4 states
Price	expensive	cheap	the same capacity can be stored in less silicon

¹⁾ Not recommended for OEM market or industrial applications

7 Electrical Specification

Absolute Maximum Ratings

Parameter	Symbol	Min	Max	Unit
Power Supply Voltage	V_Bus	-0.5	6.0	V
Voltage on D+ and D-	V_Data	-0.5	3.6	
Commercial Operating Temperature	T_A	0	70	°C
Extended Operating Temperature		-25	85	
Industrial Operating Temperature		-40	85	

DC characteristics for Full-Speed operation (T=25°C, V_Bus=5V)

Parameter	Symbol	Test condition	Min	Typ	Max	Unit
Supply Voltage	V_Bus		4.75	5.00	5.25	V
Operating current	I_CC	V_Bus=5.0V	60	90	120	mA
Suspend current	I_CCS		350		500	µA
Input LOW Voltage	V_IL				0.8	V
Input HIGH Voltage	V_IH		2			
Output LOW Voltage	V_OL	R _L of 1.5kΩ to 3.6V			0.3	
Output HIGH Voltage	V_OH	R _L of 15kΩ to GND	2.8		3.6	
Output Signal Crossover Voltage	V_CRS		1.3		2.0	

DC characteristics for High-Speed operation (T=25°C, V_Bus=5V)

Parameter	Symbol	Test condition	Min	Typ	Max	Unit
Supply Voltage	V_Bus		4.75	5.00	5.25	V
Operating current	I_CC	V_Bus=5.0V	60	100	180	mA
Suspend current	I_CCS		350		500	µA
High Speed Idle Level	V_HSOI		-10		10	mV
High Speed Data Signaling LOW	V_HSOL		-10		10	
High Speed Data Signaling HIGH	V_HSOH		360		440	
Chirp J Level (differential)	V_CHIRPJ		360		440	
Chirp K Level (differential)	V_CHIRPK		-440		-360	

8 Environmental Specification and Reliability

8.1 Recommended operating conditions

Parameter	Symbol	Min	Typ	Max	Unit
Commercial Operating Temperature	T_A	0	25	70	°C
Extended Operating Temperature		-25		85	
Industrial Operating Temperature		-40		85	
Storage Temperature	T_S	-50		100	

8.2 Reliability

Parameter	Value
Endurance (SLC NAND Flash)	~2'000'000 cycles ¹⁾
Data reliability	1 in 10 ¹⁴ bits, read
Error correction code (ECC)	BCH detect up to 9-bit errors / correct up to 8-bit errors per sector
MTBF / MTF	> 3,000,000 hours
Data retention	10 years @ 10% life time / 1 years @ life end
Durability	> 1500 insertions / removals

¹⁾ 100'000 program/erase cycles NAND Flash cell endurance / average file size written = 5% of device capacity (50MB for 1GB device)/no static data

8.3 Shock, Vibration, and Humidity

Parameter	Value
Shock	1500G Peak, 0.5m pulse duration, 5 pulses, 6 axes (JESD22-B110)
Vibration	20G Peak, 20-2000 Hz, 4 cycles per direction (X, Y and Z) (JESD22-B103)
Humidity	85°C, 85% RH, V _{max} for 500 hrs (JESD22-A101)

9 Compatibility & Compliance

- Configurable as boot-drive
- Standard fix Configuration (mounted as local drive, not as removable drive)
- Operating Systems:
 - Windows CE
 - Windows Server 2003 and 2008
 - Windows 7, Vista, XP, 2000, ME
 - Win98 SE (driver available)
 - Mac 9.0 and newer
 - Mac 8.6 (with driver) and newer
 - Linux 2.4 and newer
 - All USB mass-storage host systems (guarantee on all USB-IF certified systems)
- CE – EN 55022/55024
- FCC class B for information technology
- USB-IF high speed certified
- RoHS
- UL60950 compliant PCB
- WEEE

10 Applications

- Gaming
- Industrial PCs
- Point-Of-Sale (POS)
- Industrial Automation
- Networking Equipment
- Medical Equipment
- Data Recorders

11 Performance reference

11.1 Test Equipment

Mainboard:	ASUS P5LD2	CPU:	Intel Core 2 4400 @2.0GHz
OS:	Win XP Prof. V.2002 SP3	Testsoftware:	Swissbit FlashTest 1.2.1/1.3.0 / Script „Performance“
Firmware:	I0112 / K1128 BB	Prod.Tool:	SPT 1.0.22/23 SDK: 1.0.24
Filesystem:	Low level		

11.2 Performance results

The effective speed depends on Controller, Number and type of flash, File system and file size, Test tool & OS. Cards with the low-profile connector (Partnumber ... K1BP...) have the same properties.

	Random Read [kByte/sec]		Random Write [kByte/sec]	
	8 sector - 4kByte	128 sector - 64kByte	8 sector - 4kByte	128 sector - 64kByte
SFUI1024J1BP2TO-I-MS*	~5800	~24800	~100	~1600
SFUI2048J1BP2TO-I-DS*	~5800	~26500	~75	~1200
SFUI4096J1BP2TO-I-DT*	~5800	~26000	~75	~1150
SFUI8192J1BP2TO-I-QT*	~5400	~25900	~75	~1150
SFU*16GBE1BP2MT-t-QT*	~5100	~25900	~40	~650

	Sequential Read [kByte/sec]		Sequential Write [kByte/sec]	
	8 sector - 4kByte	128 sector - 64kByte	8 sector - 4kByte	128 sector - 64kByte
SFUI1024J1BP2TO-I-MS*	~7800	~26200	~6500	~8100
SFUI2048J1BP2TO-I-DS*	~8100	~28500	~4600	~11800
SFUI4096J1BP2TO-I-DT*	~8100	~28700	~4600	~20800
SFUI8192J1BP2TO-I-QT*	~8000	~28900	~4600	~20800
SFU*16GBE1BP2MT-t-QT*	~7800	~28700	~4000	~20950

12 Standard form factors and hardware

- Standard form factor of PCBs 36.8mm x 26.65mm
- Hole for mechanical fixture (optional grounded)
- Shield (connector Pin 10) grounded (optional NC)
- 2 additional holes
- LED for operation indication (optional no LED)
- 2 connector types
 - 2.54mm pitch, 7.5mm long standard
 - 2.00mm pitch, 3.6mm long low profile
- Component heights
 - max. 1.6mm on connector side
 - max. 1.2mm on flash side (2.4mm for stacked flash)

Figure 1: Mechanical Dimensions for 2.54mm connector (standard)

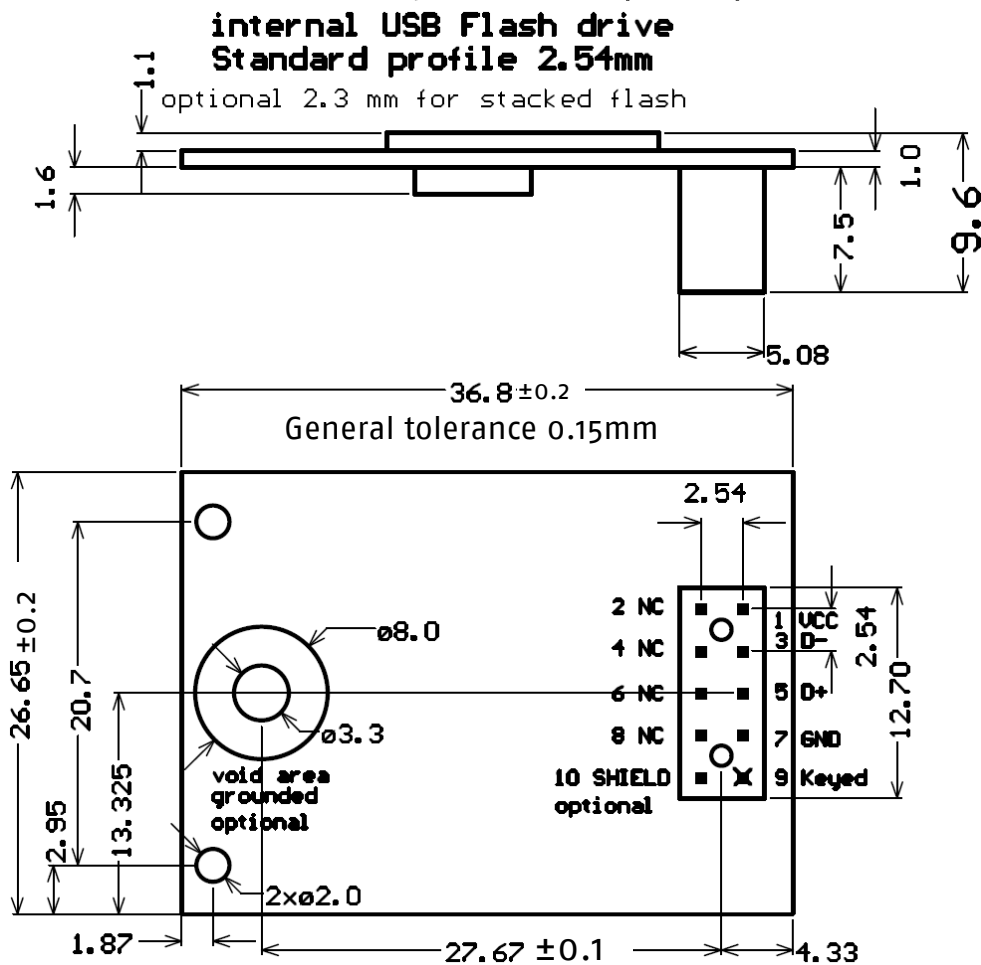
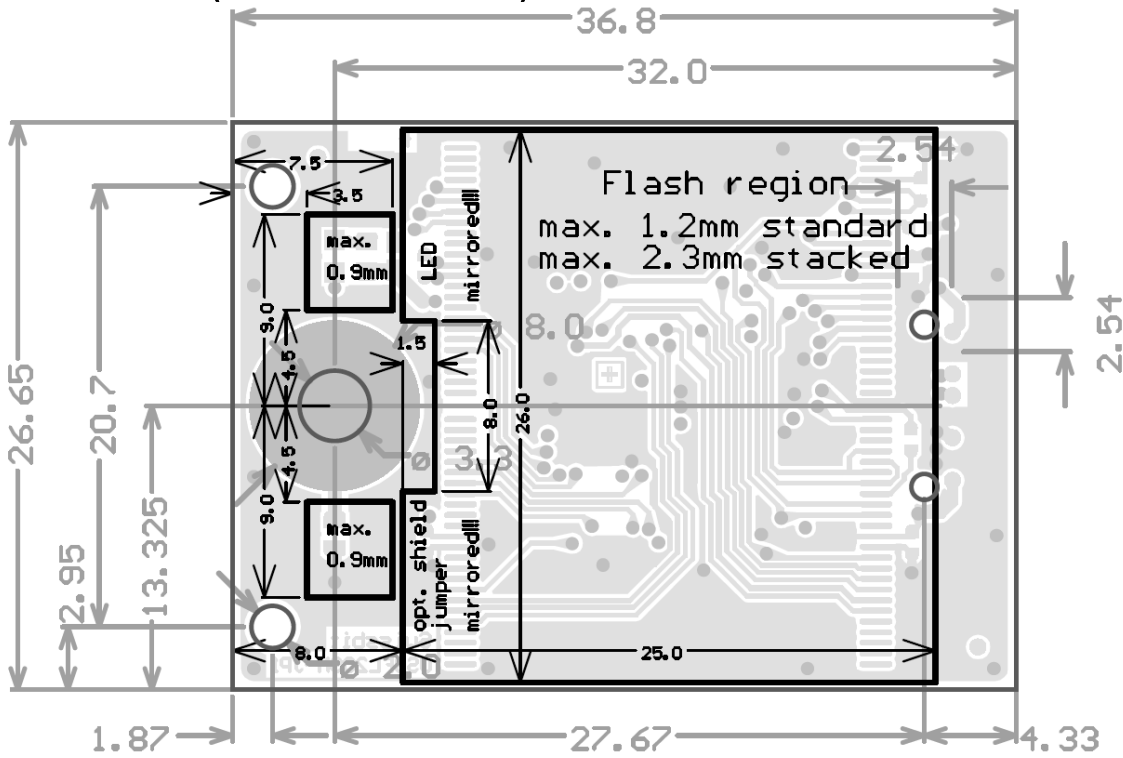

Figure 4: Component region on flash side (symmetric to center line, general tolerance 0.2mm)
mirrored (view from connector side)



13 RoHS and WEEE update from Swissbit

Dear Valued Customer,

We at Swissbit place great value on the environment and thus pay close attention to the diverse aspects of manufacturing environmentally and health friendly products. The European Parliament and the Council of the European Union have published two Directives defining a European standard for environmental protection. This states that CompactFlash Cards must comply with both Directives in order for them to be sold on the European market:

- **RoHS** – Restriction of Hazardous Substances
- **WEEE** – Waste Electrical and Electronic Equipment

Swissbit would like to take this opportunity to inform our customers about the measures we have implemented to adapt all our products to the European norms.

What is the WEEE Directive (2002/96/EC)?

The Directive covers the following points:

- Prevention of WEEE
- Recovery, recycling and other measures leading to a minimization of wastage of electronic and electrical equipment
- Improvement in the quality of environmental performance of all operators involved in the EEE life cycle, as well as measures to incorporate those involved at the EEE waste disposal points

What are the key elements?

The WEEE Directive covers the following responsibilities on the part of producers:

Producers must draft a disposal or recovery scheme to dispose of EEE correctly.
Producers must be registered as producers in the country in which they distribute the goods.
They must also supply and publish information about the EEE categories.
Producers are obliged to finance the collection, treatment and disposal of WEEE.

Inclusion of WEEE logos on devices

In reference to the Directive, the WEEE logo must be printed directly on all devices that have sufficient space. «In exceptional cases where this is necessary because of the size of the product, the symbol of the WEEE Directive shall be printed on the packaging, on the instructions of use and on the warranty»
(WEEE Directive 2002/96/EC)

When does the WEEE Directive take effect?

The Directive came into effect internationally on 13 August, 2005.

What is RoHS (2002/95/EC)?

The goals of the Directive are to:

- Place less of a burden on human health and to protect the environment by restricting the use of hazardous substances in new electrical and electronic devices
- To support the WEEE Directive (see above)

RoHS enforces the restriction of the following 6 hazardous substances in electronic and electrical devices:

- Lead (Pb) – no more than 0.1% by weight in homogeneous materials
- Mercury (Hg) – no more than 0.1% by weight in homogeneous materials
- Cadmium (Cd) – no more than 0.01% by weight in homogeneous materials
- Chromium (Cr6+) – no more than 0.1% by weight in homogeneous materials
- PBB, PBDE – no more than 0.1% by weight in homogeneous materials

Swissbit is obliged to minimize the hazardous substances in the products.

According to part of the Directive, manufacturers are obliged to make a self-declaration for all devices with RoHS. Swissbit carried out intensive tests to comply with the self-declaration. We have also already taken steps to have the analyses of the individual components guaranteed by third-party companies.

Swissbit carried out the following steps during the year with the goal of offering our customers products that are fully compliant with the RoHS Directive.

- **Preparing all far-reaching directives, logistical enhancements and alternatives regarding the full understanding and introduction of the RoHS Directive's standards**
- **Checking the components and raw materials:**
 - Replacing non-RoHS-compliant components and raw materials in the supply chain
 - Cooperating closely with suppliers regarding the certification of all components and raw materials used by Swissbit
- **Modifying the manufacturing processes and procedures**
 - Successfully adapting and optimizing the new management-free integration process in the supply chain
 - Updating existing production procedures and introducing the new procedures to support the integration process and the sorting of materials
- **Carrying out the quality process**
 - Performing detailed function and safety tests to ensure the continuous high quality of the Swissbit product line

When does the RoHS Directive take effect?

As of 1 July, 2006, only new electrical and electronic devices with approved quantities of RoHS will be put on the market.

When will Swissbit be offering RoHS-approved products?

Swissbit's RoHS-approved products are available now. Please contact your Swissbit contact person to find out more about exchanging your existing products for RoHS-compliant devices.

For your attention

We understand that packaging and accessories are not EEE material and are therefore not subject to the WEEE or RoHS Directives.

Contact details:

Swissbit AG
Industriestrasse 4
CH 9552 Bronschhofen
Tel: +41 71 913 03 03 – Fax: +41 71 913 03 15
E-mail: industrial@swissbit.com – Website: www.swissbit.com

14 Best Practices

There are a number of best practices to reach the maximum life time.

14.1 Wear Leveling and Spare Block Management

The device uses zone based flash management (zones also called as management units). This means that the user accessible data range (LBA area) is evenly divided into multiple zones, which are all managed separately for both, wear leveling (dynamic and static) and for spare & bad block management.

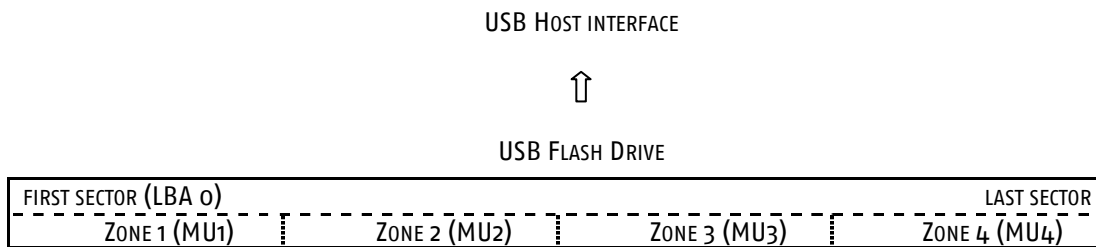

*MU=Management Unit

The number of zones is depending on the device capacity and can be read out using the Swissbit Life Time Monitoring tool. The tool will show the number of available spare blocks per management unit (zone). The devices need a minimum number of 2 spare blocks per unit to work with. If the first unit reaches this value, the device will be write-protected by the firmware.

To get optimal life time, write accesses must be evenly distributed over all zones. This can, for example, be achieved by using multiple partitions and by then distributing the data between the partitions.

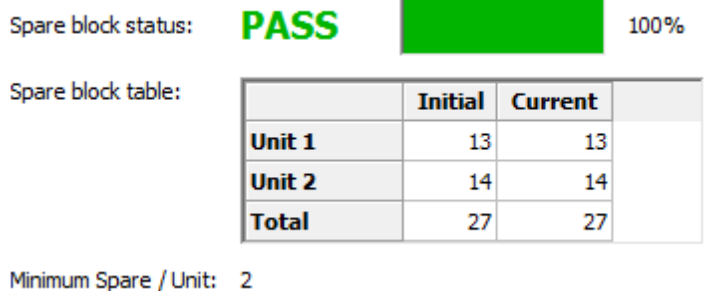

14.1 Device Removal & Power Failure

User data can be lost or corrupted if power is interrupted while the UFD is writing data. To avoid data loss, it is necessary to avoid power interruption while the device is busy. This can be made sure by always using the host (e.g. Windows) shutdown mechanisms or by detaching the device in the operating system before unplugging it. Swissbit also offers an Application Note "Design-In Guide" that describes techniques to reduce data loss on power failure, if power failure absolutely can't be avoided.

14.2 Lifetime end handling

If the flash reaches its end of life, the number of bad blocks will increase (bad flash blocks will be replaced with spare blocks). There exist different side effects with negative data influence by degraded flash cells. Sometimes bit errors can occur because of effects that are not immediately detected by the flash, e.g. effects like program disturb or read disturb, which means that the bad block recognition does not always prevent data loss. When the number of bit errors in a sector exceeds the ECC correcting capabilities, invalid (uncorrected) data can be reported back to the host. Because of these effects it is strongly recommended to replace devices that are nearing their end of life. One good indicator would be the current spare blocks per unit should not be reducing below 5. It is in the responsibility of the system integrator to account for the flash usage per zone. Swissbit offers support for calculating expected life time if the exact use case is provided (e.g. by providing low level [USB interface] write statistics).

For notes on reducing flash stress, Swissbit offers an Application Note called "Design-In Guide".

Please contact your sales channel for more information or send a mail to sales@swissbit.com.

15 Part Number Decoder

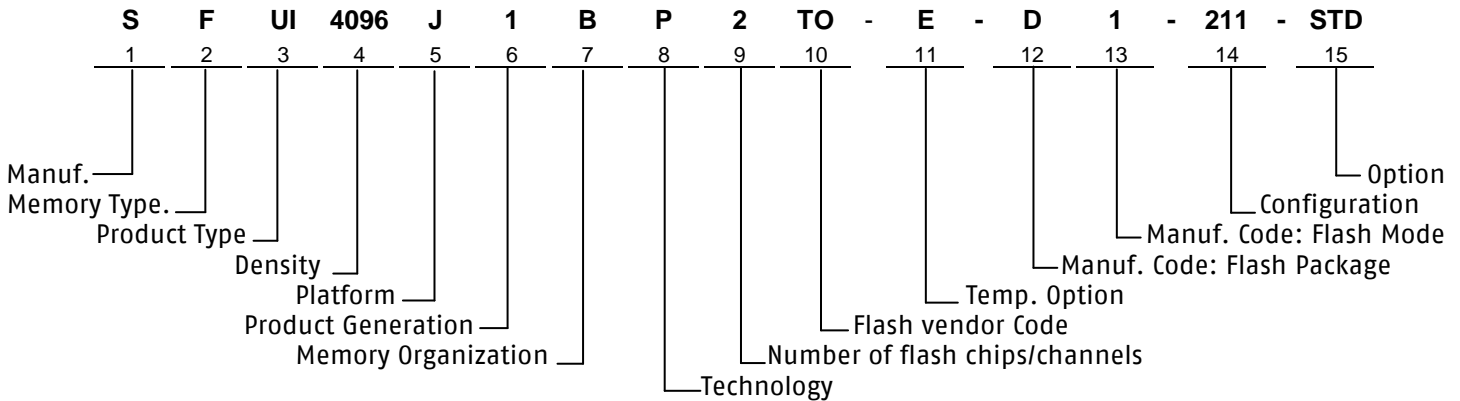

1. Manufacturer

Swissbit	S
----------	---

2. Memory Type

Flash	F
-------	---

3. Product Type

U-1xx USB Flash Drive Module (Internal)	UI
---	----

4. Capacity

1 GB	1024
2 GB	2048
4 GB	4096
8 GB	8192
16 GB	16384

5. Platform

U-1xx – 2.54mm plug	J
U-1xx – 2.00mm plug	K

6. Product Generation

7. Memory Organization

x8	B
----	---

8. Technology

U-100 technology	F
U-110 technology	P

9. Number of Flash channels

1 Flash	1
2 Flash	2

10. Flash Code

Samsung	SA
Toshiba	TO
Micron	MT

11. Temp. Option

Industrial Temp. Range -40°C to 85°C	I
Extended Temp. Range -25°C to 85°C	E
Standard Temp. Range 0°C to 70°C	C

12. DIE Classification

SLC MONO (single die package)	M
SLC DDP (dual die package)	D
SLC QDP (quad die package)	Q

13. PIN Mode

Normal nCE & R/nB	0/S
Dual nCE & Dual R/nB	1/T

14. UFD XYZ

X → Setting

Fix Drive	2
-----------	---

Y → Firmware revision per product generation

Revision 1	1
Revision 2	2

Z → Optional setting

default	1
---------	---

15. Option

Swissbit / Standard	STD
Customized version	XXX

16 Label

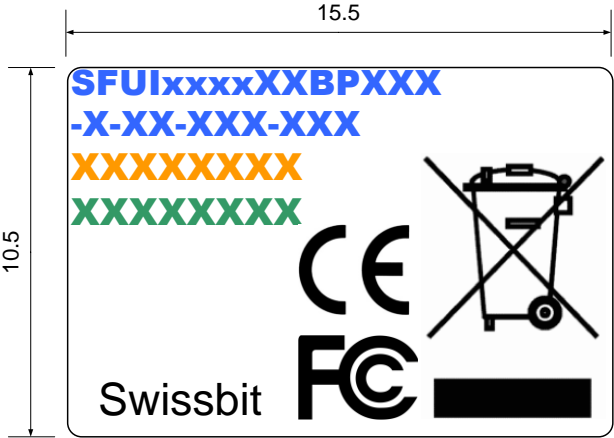

SFUIxxxxXXBPXXX	Part Number
-X-XX-XXX-XXX	
XXXXXXXX	Lot Code
XXXXXXXX	Type No.

17 RoHS and WEEE update from Swissbit

Dear Valued Customer,

We at Swissbit place great value on the environment and thus pay close attention to the diverse aspects of manufacturing environmentally and health friendly products. The European Parliament and the Council of the European Union have published two Directives defining a European standard for environmental protection. This states that CompactFlash Cards must comply with both Directives in order for them to be sold on the European market:

- **RoHS** – Restriction of Hazardous Substances
- **WEEE** – Waste Electrical and Electronic Equipment

Swissbit would like to take this opportunity to inform our customers about the measures we have implemented to adapt all our products to the European norms.

What is the WEEE Directive (2002/96/EC)?

The Directive covers the following points:

- Prevention of WEEE
- Recovery, recycling and other measures leading to a minimization of wastage of electronic and electrical equipment
- Improvement in the quality of environmental performance of all operators involved in the EEE life cycle, as well as measures to incorporate those involved at the EEE waste disposal points

What are the key elements?

The WEEE Directive covers the following responsibilities on the part of producers:

Producers must draft a disposal or recovery scheme to dispose of EEE correctly.
Producers must be registered as producers in the country in which they distribute the goods.
They must also supply and publish information about the EEE categories.
Producers are obliged to finance the collection, treatment and disposal of WEEE.

Inclusion of WEEE logos on devices

In reference to the Directive, the WEEE logo must be printed directly on all devices that have sufficient space. «In exceptional cases where this is necessary because of the size of the product, the symbol of the WEEE Directive shall be printed on the packaging, on the instructions of use and on the warranty»
(WEEE Directive 2002/96/EC)

When does the WEEE Directive take effect?

The Directive came into effect internationally on 13 August, 2005.

What is RoHS (2002/95/EC)?

The goals of the Directive are to:

- Place less of a burden on human health and to protect the environment by restricting the use of hazardous substances in new electrical and electronic devices
- To support the WEEE Directive (see above)

RoHS enforces the restriction of the following 6 hazardous substances in electronic and electrical devices:

- Lead (Pb) – no more than 0.1% by weight in homogeneous materials
- Mercury (Hg) – no more than 0.1% by weight in homogeneous materials
- Cadmium (Cd) – no more than 0.01% by weight in homogeneous materials
- Chromium (Cr6+) – no more than 0.1% by weight in homogeneous materials
- PBB, PBDE – no more than 0.1% by weight in homogeneous materials

Swissbit is obliged to minimize the hazardous substances in the products.

According to part of the Directive, manufacturers are obliged to make a self-declaration for all devices with RoHS. Swissbit carried out intensive tests to comply with the self-declaration. We have also already taken steps to have the analyses of the individual components guaranteed by third-party companies.

Swissbit carried out the following steps during the year with the goal of offering our customers products that are fully compliant with the RoHS Directive.

- **Preparing all far-reaching directives, logistical enhancements and alternatives regarding the full understanding and introduction of the RoHS Directive's standards**
- **Checking the components and raw materials:**
 - Replacing non-RoHS-compliant components and raw materials in the supply chain
 - Cooperating closely with suppliers regarding the certification of all components and raw materials used by Swissbit
- **Modifying the manufacturing processes and procedures**
 - Successfully adapting and optimizing the new management-free integration process in the supply chain
 - Updating existing production procedures and introducing the new procedures to support the integration process and the sorting of materials
- **Carrying out the quality process**
 - Performing detailed function and safety tests to ensure the continuous high quality of the Swissbit product line

When does the RoHS Directive take effect?

As of 1 July, 2006, only new electrical and electronic devices with approved quantities of RoHS will be put on the market.

When will Swissbit be offering RoHS-approved products?

Swissbit's RoHS-approved products are available now. Please contact your Swissbit contact person to find out more about exchanging your existing products for RoHS-compliant devices.

For your attention

We understand that packaging and accessories are not EEE material and are therefore not subject to the WEEE or RoHS Directives.

Contact details:

Swissbit AG
Industriestrasse 4
CH 9552 Bronschhofen
Tel: +41 71 913 03 03 – Fax: +41 71 913 03 15
E-mail: industrial@swissbit.com – Website: www.swissbit.com

18 Revision History

Document Revision History

Date	Revision	Revision Details
23-November-2009	1.00	Final release
28-October-2010	1.10	General part numbers update, speed values for Toshiba flash
18-June-2012	1.20	Add 16GB UFD, add best practices

Disclaimer:

No part of this document may be copied or reproduced in any form or by any means, or transferred to any third party, without the prior written consent of an authorized representative of Swissbit AG ("SWISSBIT"). The information in this document is subject to change without notice. SWISSBIT assumes no responsibility for any errors or omissions that may appear in this document, and disclaims responsibility for any consequences resulting from the use of the information set forth herein. SWISSBIT makes no commitments to update or to keep current information contained in this document. The products listed in this document are not suitable for use in applications such as, but not limited to, aircraft control systems, aerospace equipment, submarine cables, nuclear reactor control systems and life support systems. Moreover, SWISSBIT does not recommend or approve the use of any of its products in life support devices or systems or in any application where failure could result in injury or death. If a customer wishes to use SWISSBIT products in applications not intended by SWISSBIT, said customer must contact an authorized SWISSBIT representative to determine SWISSBIT willingness to support a given application. The information set forth in this document does not convey any license under the copyrights, patent rights, trademarks or other intellectual property rights claimed and owned by SWISSBIT. The information set forth in this document is considered to be "Proprietary" and "Confidential" property owned by SWISSBIT.

ALL PRODUCTS SOLD BY SWISSBIT ARE COVERED BY THE PROVISIONS APPEARING IN SWISSBIT'S TERMS AND CONDITIONS OF SALE ONLY, INCLUDING THE LIMITATIONS OF LIABILITY, WARRANTY AND INFRINGEMENT PROVISIONS. SWISSBIT MAKES NO WARRANTIES OF ANY KIND, EXPRESS, STATUTORY, IMPLIED OR OTHERWISE, REGARDING INFORMATION SET FORTH HEREIN OR REGARDING THE FREEDOM OF THE DESCRIBED PRODUCTS FROM INTELLECTUAL PROPERTY INFRINGEMENT, AND EXPRESSLY DISCLAIMS ANY SUCH WARRANTIES INCLUDING WITHOUT LIMITATION ANY EXPRESS, STATUTORY OR IMPLIED WARRANTIES OF MERCHANTABILITY OR FITNESS FOR A PARTICULAR PURPOSE.

©2012 SWISSBIT AG All rights reserved.