

Sensors and Switches in Oxygen Concentrator Applications

BACKGROUND

An oxygen concentrator reduces the amount of nitrogen in the air, increasing the oxygen level delivered to the patient. Oxygen concentrators are often used with patients, such as those with lung disease, who have difficulty absorbing oxygen into the blood stream. (See Figure 1.)

SOLUTIONS

Honeywell manufactures many products that may be used in oxygen concentrators. They are designed to help control pressure, airflow and temperature. (See Figure 2.)

Figure 1. Oxygen Concentrator



Figure 2. Potential Honeywell Products Used in Oxygen Concentrator Applications

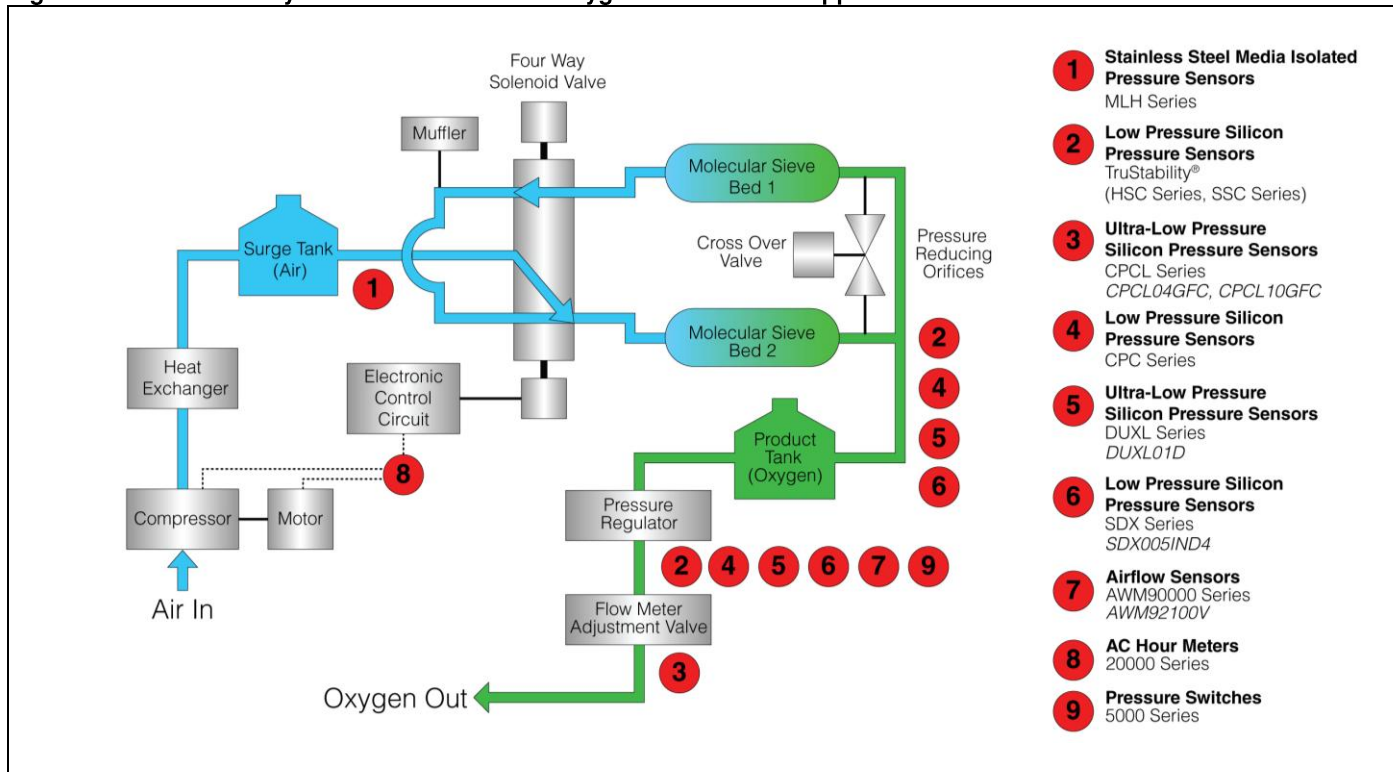

Sensors and Switches in Oxygen Concentrator Applications

Pressure Sensors

Low and Ultra-Low Pressure Silicon: Honeywell's TruStability® (HSC Series and SSC Series), CPCL Series, CPC Series, DUXL Series, and SDX Series may be used to detect when the patient begins to inhale so that oxygen can then be delivered efficiently and effectively. Not only does this enhance system response time, it also minimizes wasting oxygen when the patient isn't inhaling, allowing the

oxygen concentrator to be smaller and to operate more efficiently. Smaller equipment size also means lower power consumption, as well as greater portability. (See Table 1.)

Stainless Steel Media Isolated: The MLH Series senses pressure from the surge tank, providing feedback to the compressor which allows the compressor to maintain the appropriate pressure level. (See Table 2.)

Table 1. Low and Ultra-Low Plastic Silicon Pressure Sensors







(Low) TruStability® Silicon Pressure Sensors (HSC Series and SSC Series)	(Ultra-Low) CPCL Series CPCL04GFC, CPCL10GFC	(Low) CPC Series	(Ultra-Low) DUXL Series DUXL01D	(Low) SDX Series SDX005IND4
				
Features and Benefits				
<ul style="list-style-type: none"> • Temperature compensation and calibration provide an amplified signal, typically allowing removal of components associated with signal conditioning from the PCB, increasing space and reducing associated costs • Industry-leading stability often eliminates need for calibration after PCB mount, and periodically over time • Digital ASIC output in either I²C or SPI protocols from digital sensors accelerates performance through reduced conversion requirements and the convenience of direct interface to microprocessors and microcontrollers • Multiple packaging, mounting, power, and signal options combine with customized calibration capabilities increases application flexibility 	<ul style="list-style-type: none"> • Tube arrangements with nylon housing allow use in potential applications requiring small size or vacuum reference • Designed for use with non-corrosive, non-ionic pressure media, including many potential medical application gases • Calibrated and temperature compensated • Small size allows use in compact equipment • Reduced-cost • Absolute, differential, gage • Pressure ranges: <ul style="list-style-type: none"> - CPCL: 0 in H₂O to 5 in H₂O (inclusive) - CPC: 0 psi to 150 psi (inclusive) 	<ul style="list-style-type: none"> • Calibrated and temperature compensated • Ratiometric mV output • Used where customized external signal conditioning is required or available from other sources • Low profile outline for use in most portable applications where small size is necessary • Differential, gage • 0 in H₂O to 5 in H₂O pressure range (inclusive) 	<ul style="list-style-type: none"> • Calibrated and temperature compensated to promote stable output over temperature range • Small, DIP package allows use of multiple sensors in limited space, as well as use in compact equipment • Solvent-resistant case provides enhanced corrosion resistance and isolation to external stress • Differential, gage • 0 in H₂O to 5 in H₂O pressure range 	

Table 2. Stainless Steel Media Isolated Pressure Sensors

MLH Series	Features and Benefits
	<ul style="list-style-type: none"> • Media isolated transducer (stainless steel wetted surfaces) designed for compatibility with many corrosive fluids and gases • Threaded pressure port designed for simplified installation in customer manifold • Optional weldable interface designed to support a hermetic interface • Temperature-compensated electrical output • Amplified and non-amplified options

Sensors and Switches in Oxygen Concentrator Applications

Airflow Sensors

The AWM90000 Series is designed to detect ultra-low flow levels at 0.1 cm³. This enhanced sensitivity may be used to detect when the patient exhales and when the system should

reduce airflow, easing exhalation and improving patient comfort. Honeywell's airflow sensors deliver a low pressure drop (down to 0.2 cm H₂O at 200 SLPM), leading to lower flow resistance and improved patient comfort. (See Table 3.)

Table 3. Airflow Sensors

AWM90000 Series AWM92100V	Features and Benefits
	<ul style="list-style-type: none"> • Sensitivity to low flows (0.1 SCCM to 200 SLPM) • Analog output • Bi-directional sensing • Low differential pressure sensing • Low power consumption • Actual mass airflow sensing • Enhanced response time • Precision silicon micromachining • Cost-effective

AC Hour Meters

Honeywell's 20000 Series is designed to track machine usage in hours and tenths of an hour via a readily-visible readout. This information may then be used to validate total hours of machine operation for maintenance purposes or usage on a

per-patient basis to determine compliance or enhance billing accuracy. Hour meters are frequently found on the external control panel and are usually activated by the motor or compressor. (See Table 4.)

Table 4. AC Hour Meters

20000 Series	Features and Benefits
	<ul style="list-style-type: none"> • Accuracy of ±0.02% • Rugged construction promotes vibration and shock resistance • Low power consumption • UL, CSA, CE approvals • Tamper-proof • Design allows meter to be readable with the power off

Pressure Switches

Honeywell's 5000 Series is often located on the output of the oxygen concentrator's pressure regulator and acts as a high pressure warning, alerting the user by activating an indicator

light if the pressure exceeds a specified limit. In some cases, it may also shut down the motor. Honeywell's pressure switch products are reliable and highly accurate. (See Table 5.)

Table 5. Pressure Switches

5000 Series	Features and Benefits
	<ul style="list-style-type: none"> • Enhanced response time of 5 ms or less • Stands up to many extended duty applications • Factory set, capable of field adjustment • Direct acting blade, gold-plated contacts • No dead band • Kapton diaphragm for compatibility with a variety of media • Variety of electrical connections and terminations available • Optional rubber boot

Sensors and Switches in Oxygen Concentrator Applications

WARNING

PERSONAL INJURY

DO NOT USE these products as safety or emergency stop devices or in any other application where failure of the product could result in personal injury.

Failure to comply with these instructions could result in death or serious injury.

WARRANTY/REMEDY

Honeywell warrants goods of its manufacture as being free of defective materials and faulty workmanship. Honeywell's standard product warranty applies unless agreed to otherwise by Honeywell in writing; please refer to your order acknowledgement or consult your local sales office for specific warranty details. If warranted goods are returned to Honeywell during the period of coverage, Honeywell will repair or replace, at its option, without charge those items it finds defective. **The foregoing is buyer's sole remedy and is in lieu of all other warranties, expressed or implied, including those of merchantability and fitness for a particular purpose. In no event shall Honeywell be liable for consequential, special, or indirect damages.**

While we provide application assistance personally, through our literature and the Honeywell web site, it is up to the customer to determine the suitability of the product in the application.

Specifications may change without notice. The information we supply is believed to be accurate and reliable as of this printing. However, we assume no responsibility for its use.

WARNING

MISUSE OF DOCUMENTATION

- The information presented in this application note is for reference only. Do not use this document as a product installation guide.
- Complete installation, operation, and maintenance information is provided in the instructions supplied with each product.

Failure to comply with these instructions could result in death or serious injury.

SALES AND SERVICE

Honeywell serves its customers through a worldwide network of sales offices, representatives and distributors. For application assistance, current specifications, pricing or name of the nearest Authorized Distributor, contact your local sales office or:

E-mail: info.sc@honeywell.com

Internet: www.honeywell.com/sensing

Phone and Fax:

Asia Pacific	+65 6355-2828 +65 6445-3033 Fax
Europe	+44 (0) 1698 481481 +44 (0) 1698 481676 Fax
Latin America	+1-305-805-8188 +1-305-883-8257 Fax
USA/Canada	+1-800-537-6945 +1-815-235-6847 +1-815-235-6545 Fax

Sensing and Control
Honeywell
1985 Douglas Drive North
Golden Valley, MN 55422
www.honeywell.com/sensing

009047-3-EN IL50 GLO Printed in USA
November 2010
Copyright © 2010 Honeywell International Inc. All rights reserved.

Honeywell